



brother

Quick Reference Guide

Kurzanleitung

Guide de référence rapide

Beknopte bedieningshandleiding

Guida di riferimento rapido

Guía de referencia rápida

Guia de referência rápida

Краткий справочник

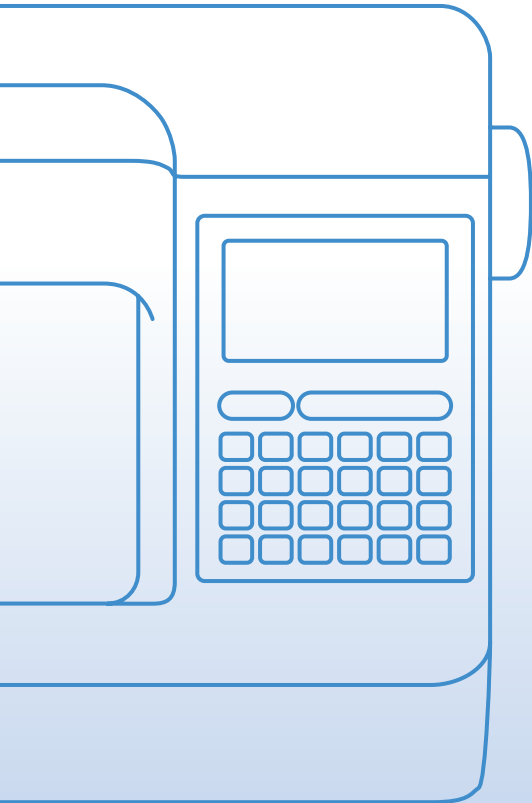

Be sure to read this document before using the machine.
We recommend that you keep this document nearby for future reference.

Lesen Sie dieses Dokument, bevor Sie die Maschine verwenden.
Es wird empfohlen, dieses Dokument griffbereit aufzubewahren, damit Sie jederzeit darin nachschlagen können.

Veillez à lire ce document avant d'utiliser la machine.
Nous vous conseillons de conserver ce document à portée de main pour vous y référer ultérieurement.

Lees dit document voordat u de machine gebruikt.
Houd dit document bij de hand, zodat u het kunt raadplegen.

Leggere questo documento prima di utilizzare la macchina.
Si consiglia di conservare questo documento a portata di mano per un eventuale riferimento futuro.

Lea este documento antes de utilizar la máquina.
Recomendamos que tenga este documento a mano por si necesita consultarlo más adelante.

Certifique-se de ler este documento antes de utilizar a máquina.
Recomendamos guardar este documento em um lugar de fácil acesso para futuras referências.

Обязательно прочитайте этот документ перед началом работы на машине!
Рекомендуется хранить данный документ в удобном месте, чтобы он был доступен для справок.

Before using your machine for the first time please read the “IMPORTANT SAFETY INSTRUCTIONS” in the Operation Manual.

Refer to the Operation Manual for detailed instructions. In this guide, English screens are used for basic explanations.

Avant d'utiliser votre machine pour la première fois, veuillez lire les « INSTRUCTIONS DE SÉCURITÉ IMPORTANTES » indiquées dans le Manuel d'instructions.

Reportez-vous au Manuel d'instructions pour des informations détaillées. Les écrans de ce guide sont en anglais pour les explications de base.

Prima di utilizzare la macchina per la prima volta, leggere “IMPORTANTI ISTRUZIONI DI SICUREZZA” nel Manuale di istruzioni.

Per le istruzioni dettagliate, consultare il Manuale di istruzioni. Nella presente guida si utilizzano le schermate in inglese per le spiegazioni di base.

Antes de utilizar a sua máquina pela primeira vez, leia as “INSTRUÇÕES DE SEGURANÇA IMPORTANTES” no Manual de Operações.

Consulte o Manual de Operações para obter instruções detalhadas.

Neste manual, as telas em inglês são usadas para as explicações básicas.

Bevor Sie die Maschine zum ersten Mal verwenden, lesen Sie bitte „WICHTIGE SICHERHEITSHINWEISE“ in der Bedienungsanleitung.

Ausführliche Hinweise finden Sie in der Bedienungsanleitung. In dieser Anleitung werden für die grundlegenden Erläuterungen englischsprachige Bildschirme verwendet.

Lees – voordat u de machine de eerste keer gebruikt – de “BELANGRIJKE VEILIGHEIDSINSTRUCTIES” in de Bedieningshandleiding.

In de Bedieningshandleiding vindt u uitvoerige aanwijzingen. In deze gids worden Engelse schermen gebruikt bij de uitleg van basisbewerkingen.

Antes de utilizar la máquina por primera vez, lea las “INSTRUCCIONES DE SEGURIDAD IMPORTANTES” en el Manual de instrucciones.

Consulte las instrucciones detalladas en el Manual de instrucciones.

En esta guía, para las explicaciones básicas se utilizan pantallas en inglés.

Перед первым использованием машины прочитайте раздел “ВАЖНЫЕ ИНСТРУКЦИИ ПО БЕЗОПАСНОСТИ” в Руководстве пользователя.

Подробные инструкции см. в Руководстве пользователя.

В данном руководстве в качестве иллюстраций используются англоязычные экраны.

Operation Manual Notations

Descriptions in the Operation Manual are divided into those for Model 1, 2, 3 or 4, depending on the machine specifications. For this sewing machine, refer to descriptions for Model 2.

Anmerkungen in der Bedienungsanleitung

Die Beschreibungen in der Bedienungsanleitung sind entsprechend den technischen Daten einer Maschine für Modell 1, 2, 3 oder 4 aufgeteilt. Für diese Nähmaschine gelten die Beschreibungen für Modell 2.

Remarques concernant le Manuel d'instructions

Les descriptions du Manuel d'instructions sont réparties entre les modèles 1, 2, 3 et 4, selon les caractéristiques de la machine. Pour cette machine à coudre, reportez-vous aux descriptions du modèle 2.

Opmerkingen Bedieningshandleiding

De beschrijvingen in de Bedieningshandleiding zijn opgesplitst voor de modellen 1, 2, 3 of 4, afhankelijk van de specificaties van de machines. Voor deze naaimachine zijn de beschrijvingen voor model 2 van toepassing.

Note nel Manuale di istruzioni

Le descrizioni riportate nel Manuale di istruzioni sono divise per modello (Modello 1, 2, 3 o 4), a seconda delle specifiche della macchina. Per questa macchina per cucire, consultare le descrizioni per il Modello 2.

Indicaciones del Manual de instrucciones

Las explicaciones del Manual de instrucciones aparecen divididas en base a los Modelos 1, 2, 3 o 4, dependiendo de las especificaciones de la máquina. Para esta máquina de coser, consulte las descripciones para el Modelo 2.

Notações no Manual de Operações

As descrições no Manual de Operações são divididas em descrições para os Modelos 1, 2, 3 ou 4, dependendo das especificações da máquina. Para esta máquina de costura, consulte as descrições para o Modelo 2.

Обозначения в Руководстве пользователя

Описания в Руководстве пользователя приведены для нескольких моделей машины. Они обозначены как инструкции для модели 1, 2, 3 или 4. К данной швейной машине относятся описания для модели 2.

Contents

| | |
|--|-----------|
| Accessories | 4 |
| ◆ Included Accessories | 4 |
| ◆ Optional Accessories | 4 |
| Bobbin Winding and Setting | 12 |
| Upper Threading | 14 |
| Selecting and Sewing Patterns | 16 |
| ◆ Preset Utility Stitches | 16 |
| ◆ Utility Stitches | 17 |
| ◆ Decorative Stitches | 18 |
| ◆ Character stitches | 18 |
| Summary of Stitch Patterns | 19 |
| ◆ Preset Utility Stitches | 19 |
| ◆ Utility Stitches | 19 |
| ◆ Decorative Stitches | 19 |
| ◆ Character stitches | 21 |

Inhalt

| | |
|--|-----------|
| Zubehör | 4 |
| ◆ Mitgeliefertes Zubehör | 4 |
| ◆ Optionales Zubehör | 4 |
| Aufspulen des Unterfadens und Einstellung | 12 |
| Einfädeln des Oberfadens | 14 |
| Auswählen und Nähen von Stichen | 16 |
| ◆ Voreingestellte Nutztische | 16 |
| ◆ Nutztische | 17 |
| ◆ Dekorstiche | 18 |
| ◆ Buchstabenstiche..... | 18 |
| Stich-Übersicht | 19 |
| ◆ Voreingestellte Nutztische | 19 |
| ◆ Nutztische | 19 |
| ◆ Dekorstiche | 19 |
| ◆ Buchstabenstiche..... | 21 |

Table des matières

| | |
|---|-----------|
| Accessoires | 6 |
| ◆ Accessoires inclus | 6 |
| ◆ Accessoires en option | 6 |
| Bobinage et réglage de la canette | 12 |
| Enfilage supérieur | 14 |
| Sélection et couture de motifs | 16 |
| ◆ Préréglage des points de couture courants | 16 |
| ◆ Points de couture courants | 17 |
| ◆ Points décoratifs | 18 |
| ◆ Points de caractères..... | 18 |
| Sommaire des motifs de point | 19 |
| ◆ Préréglage des points de couture courants | 19 |
| ◆ Points de couture courants | 19 |
| ◆ Points décoratifs | 19 |
| ◆ Points de caractères..... | 21 |

Inhoudsopgave

| | |
|---|-----------|
| Accessoires | 6 |
| ◆ Bijgeleverde accessoires | 6 |
| ◆ Optionele accessoires..... | 6 |
| Opwinden en instellen van de spoel | 12 |
| Inrijgen van de bovendraad | 14 |
| Steken selecteren en naaien | 16 |
| ◆ Vooraf ingestelde naaisteken | 16 |
| ◆ Naaisteken | 17 |
| ◆ Decoratieve steken | 18 |
| ◆ Lettersteken | 18 |
| Steken overzicht | 19 |
| ◆ Vooraf ingestelde naaisteken | 19 |
| ◆ Naaisteken | 19 |
| ◆ Decoratieve steken | 19 |
| ◆ Lettersteken | 21 |

Sommario

| | |
|---|-----------|
| Accessori | 8 |
| ◆ Accessori in dotazione | 8 |
| ◆ Accessori opzionali | 8 |
| Avvolgimento spolina e caricamento | 12 |
| Infilatura superiore | 14 |
| Selezione e cucitura di motivi | 16 |
| ◆ Punti utili preimpostati | 16 |
| ◆ Punti utili | 17 |
| ◆ Punti decorativi | 18 |
| ◆ Punti a caratteri | 18 |
| Sommario degli schemi punto | 19 |
| ◆ Punti utili preimpostati | 19 |
| ◆ Punti utili | 19 |
| ◆ Punti decorativi | 19 |
| ◆ Punti a caratteri | 21 |

Contenido

| | |
|---|-----------|
| Accesorios | 8 |
| ◆ Accesorios incluidos | 8 |
| ◆ Accesorios opcionales | 8 |
| Bobinado y ajuste | 12 |
| Hilo superior | 14 |
| Seleccionar y coser patrones | 16 |
| ◆ Puntadas de utilidad predefinidas | 16 |
| ◆ Puntadas de utilidad | 17 |
| ◆ Puntadas decorativas | 18 |
| ◆ Puntadas de carácter | 18 |
| Resumen de tipos de puntada | 19 |
| ◆ Puntadas de utilidad predefinidas | 19 |
| ◆ Puntadas de utilidad | 19 |
| ◆ Puntadas decorativas | 19 |
| ◆ Puntadas de carácter | 21 |

Índice

| | |
|---|-----------|
| Acessórios | 10 |
| ◆ Acessórios incluídos | 10 |
| ◆ Acessórios opcionais | 10 |
| Configuração e enrolamento da bobina | 12 |
| Passagem da linha superior | 14 |
| Seleção e costura de padrões | 16 |
| ◆ Pontos utilitários predefinidos | 16 |
| ◆ Pontos utilitários | 17 |
| ◆ Pontos decorativos | 18 |
| ◆ Pontos de caracteres | 18 |
| Resumo dos padrões de ponto | 19 |
| ◆ Pontos utilitários predefinidos | 19 |
| ◆ Pontos utilitários | 19 |
| ◆ Pontos decorativos | 19 |
| ◆ Pontos de caracteres | 21 |

Содержание

| | |
|--|-----------|
| Принадлежности | 10 |
| ◆ Принадлежности в комплекте поставки | 10 |
| ◆ Дополнительные принадлежности | 10 |
| Намотка и установка шпульки | 12 |
| Заправка верхней нити | 14 |
| Выбор швейных строчек | 16 |
| ◆ Предварительно заданные основные строчки | 16 |
| ◆ Основные строчки | 17 |
| ◆ Декоративные строчки | 18 |
| ◆ Символьные строчки | 18 |
| Рисунки строчек | 19 |
| ◆ Предварительно заданные основные строчки | 19 |
| ◆ Основные строчки | 19 |
| ◆ Декоративные строчки | 19 |
| ◆ Символьные строчки | 21 |

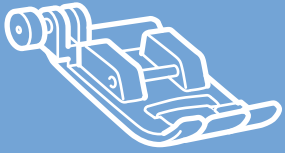

Accessories

Zubehör

◆ Included Accessories ◆ Mitgeliefertes Zubehör

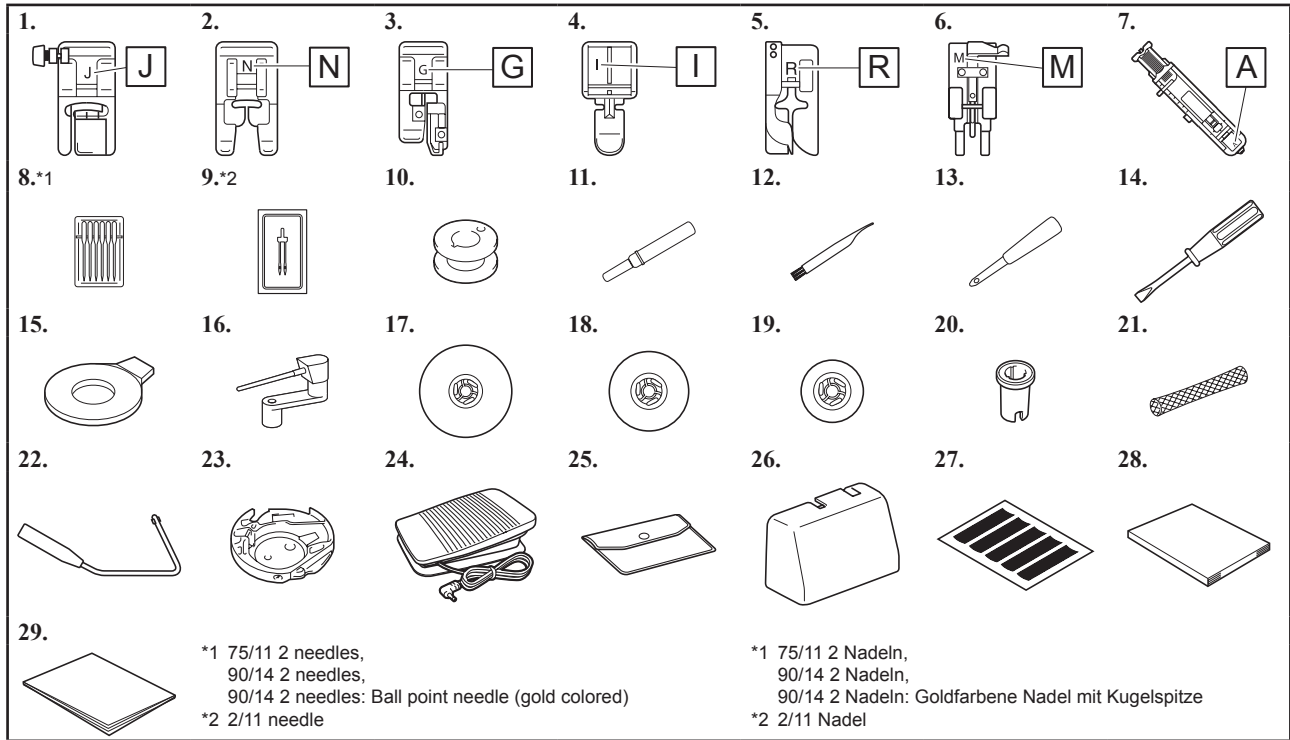

◆ Optional Accessories ◆ Optionales Zubehör

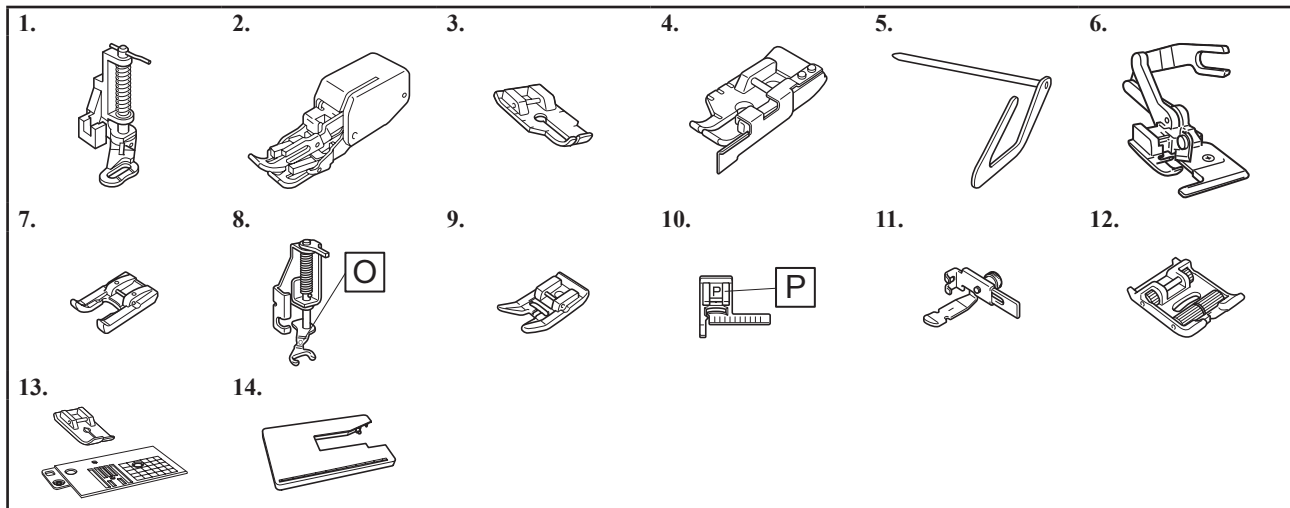

Note

- The presser foot holder screw is available through your authorized Brother dealer. (Part code: XG1343-001)
- The presser foot accessory tray is available, through your authorized Brother dealer. (Part code: XF8650-001)



Hinweis

- Die Nähfußhalterschraube ist bei Ihrem Fachhändler erhältlich. (Teilenummer: XG1343-001)
- Das Nähfußhalter-Zubehörtblett ist bei Ihrem Brother-Vertragshändler erhältlich. (Teilenummer: XF8650-001)

◆ Included Accessories

| No. | Part Name | Part Code | |
|-----|--|-----------|--|
| | | Americas | Others |
| 1 | Zigzag foot "J" (on machine) | | XF3022-001 |
| 2 | Monogramming foot "N" | | XD0810-031 |
| 3 | Overcasting foot "G" | | XC3098-031 |
| 4 | Zipper foot "I" | | X59370-021 |
| 5 | Blind stitch foot "R" | | XE2650-001 |
| 6 | Button fitting foot "M" | | XE2643-001 |
| 7 | Buttonhole foot "A" | | XC2691-023 |
| 8 | Needle set | | X58358-021 |
| 9 | Twin needle | | X59296-121 |
| 10 | Bobbin (4) (One is on machine.) | SA156*3 | SFB: XA5539-151 |
| 11 | Seam ripper | | XF4967-001 |
| 12 | Cleaning brush | | X59476-051 |
| 13 | Eyelet punch | | XZ5051-001 |
| 14 | Screwdriver | | XC8349-021 |
| 15 | Disc-shaped screwdriver | | XC1074-051 |
| 16 | Horizontal spool pin | | XC4654-251 |
| 17 | Spool cap (large) | | 130012-024 |
| 18 | Spool cap (medium) (2) (One is on machine.) | | XE1372-001 |
| 19 | Spool cap (small) | | 130013-124 |
| 20 | Thread spool insert (mini king thread spool) | | XA5752-121 |
| 21 | Spool net | | XA5523-020 |
| 22 | Knee lifter | | XA6941-052 |
| 23 | Bobbin case (on machine) | | XG2058-001 |
| 24 | Foot controller | | XZ5098-001(EU area) XZ5100-001(other areas) |
| 25 | Accessory bag | | XC4487-021 |
| 26 | Hard case | | XG5628-001 |
| 27 | Grid sheet set | | XC4549-020 |
| 28 | Operation Manual | | Contact your authorized Brother dealer. |
| 29 | Quick Reference Guide | | Contact your authorized Brother dealer. |

*3 SA156 is Class15 type bobbin.

◆ Mitgeliefertes Zubehör

| Nr. | Teilebezeichnung | Bestellnummer | |
|-----|--|----------------------|---|
| | | Nord- und Südamerika | Andere |
| 1 | Zickzackfuß „J“ (an der Maschine) | | XF3022-001 |
| 2 | Nähfuß „N“ | | XD0810-031 |
| 3 | Überwendlingfuß „G“ | | XC3098-031 |
| 4 | Reißverschlussfuß „I“ | | X59370-021 |
| 5 | Blindstichfuß „R“ | | XE2650-001 |
| 6 | Knopfannähfuß „M“ | | XE2643-001 |
| 7 | Knopflochfuß „A“ | | XC2691-023 |
| 8 | Nadelsatz | | X58358-021 |
| 9 | Zwillingsnadel | | X59296-121 |
| 10 | Spule (4) (Eine ist in der Maschine.) | SA156*3 | SFB: XA5539-151 |
| 11 | Pfeiltrenner | | XF4967-001 |
| 12 | Reinigungspinsel | | X59476-051 |
| 13 | Ahle | | XZ5051-001 |
| 14 | Schraubendreher | | XC8349-021 |
| 15 | Scheibenförmiger Schraubendreher | | XC1074-051 |
| 16 | Horizontaler Garnrollenstift | | XC4654-251 |
| 17 | Garnrollenkappe (groß) | | 130012-024 |
| 18 | Garnrollenkappe (mittel) (2) (Eine ist in der Maschine.) | | XE1372-001 |
| 19 | Garnrollenkappe (klein) | | 130013-124 |
| 20 | Garnrollenkappeneinsatz (Mini King Garnrolle) | | XA5752-121 |
| 21 | Spulennetz | | XA5523-020 |
| 22 | Kniehebel | | XA6941-052 |
| 23 | Spulenkapsel (in der Maschine) | | XG2058-001 |
| 24 | Fußpedal | | XZ5098-001(EU-Zone) XZ5100-001(Andere Zonen) |
| 25 | Zubehörtasche | | XC4487-021 |
| 26 | Tragekoffer | | XG5628-001 |
| 27 | Schabloneinsatz | | XC4549-020 |
| 28 | Bedienungsanleitung | | Wenden Sie sich an Ihr Brother-Fachgeschäft. |
| 29 | Kurzanleitung | | Wenden Sie sich an Ihr Brother-Fachgeschäft. |

*3 SA156 ist eine Class15-Spule.

◆ Optional Accessories

The following are available as optional accessories to be purchased separately from your authorized Brother dealer.

| No. | Part Name | Part Code | |
|-----|---|--------------------------|--|
| | | Americas | Others |
| 1 | Quilting foot | SA129 | F005N: XC1948-052 |
| 2 | Walking foot | SA140 | F033N: XC2214-052 |
| 3 | 1/4" quilting foot | SA125 | F001N: XC1944-052 |
| 4 | 1/4" quilting foot with guide | SA185 | F057: XC7416-252 |
| 5 | Quilting guide | SA132 | F016N: XC2215-052 |
| 6 | Side cutter "S" | SA177 | F054: XC3879-152 |
| 7 | Open toe foot | SA186 | F060: XE1094-101 |
| 8 | Free motion open toe quilting foot "O" | SA187 | F061: XE1097-001 |
| 9 | Non stick foot | SA114 | F007N: XC1949-052 |
| 10 | Stitch guide foot "P" | SA160 | F035N: XC1969-052 |
| 11 | Adjustable zipper/piping foot | SA161 | F036N: XC1970-052 |
| 12 | Roller foot | SA190 | F066: XF1723-001 |
| 13 | Straight stitch foot and needle plate set | SA564 SA564C (Canada) | SNP02: XG0946-001 SNP02AP: XG0948-001 |
| 14 | Wide table | SAWT4 | WT14: XG5051-001 WT14AP: XG4656-001 |

◆ Optionales Zubehör

Folgendes Sonderzubehör ist separat bei Ihrem Brother-Vertragshändler erhältlich.

| Nr. | Teilebezeichnung | Bestellnummer | |
|-----|--|--------------------------|--|
| | | Nord- und Südamerika | Andere |
| 1 | Freihand Stick- und Quiltfuß | SA129 | F005N: XC1948-052 |
| 2 | Stoffobertransport | SA140 | F033N: XC2214-052 |
| 3 | 1/4-Zoll-Quiltfuß | SA125 | F001N: XC1944-052 |
| 4 | 1/4-Zoll-Quiltfuß mit Führung | SA185 | F057: XC7416-252 |
| 5 | Quilt-Führung | SA132 | F016N: XC2215-052 |
| 6 | Kantenabschneider „S“ | SA177 | F054: XC3879-152 |
| 7 | Applikationsfuß | SA186 | F060: XE1094-101 |
| 8 | Offener Freihand Quiltingfuß „O“ | SA187 | F061: XE1097-001 |
| 9 | Antihafffuß | SA114 | F007N: XC1949-052 |
| 10 | Stichführungsfuß „P“ | SA160 | F035N: XC1969-052 |
| 11 | Einstellbarer Reißverschluss/Kordelfuß | SA161 | F036N: XC1970-052 |
| 12 | Rollenfuß | SA190 | F066: XF1723-001 |
| 13 | Geradstichfuß und Geradstichplatte | SA564 SA564C (Kanada) | SNP02: XG0946-001 SNP02AP: XG0948-001 |
| 14 | Maxi-Anschiebetisch | SAWT4 | WT14: XG5051-001 WT14AP: XG4656-001 |



Accessoires

Accessoires

◆ Accessoires inclus

◆ Bijgeleverde accessoires

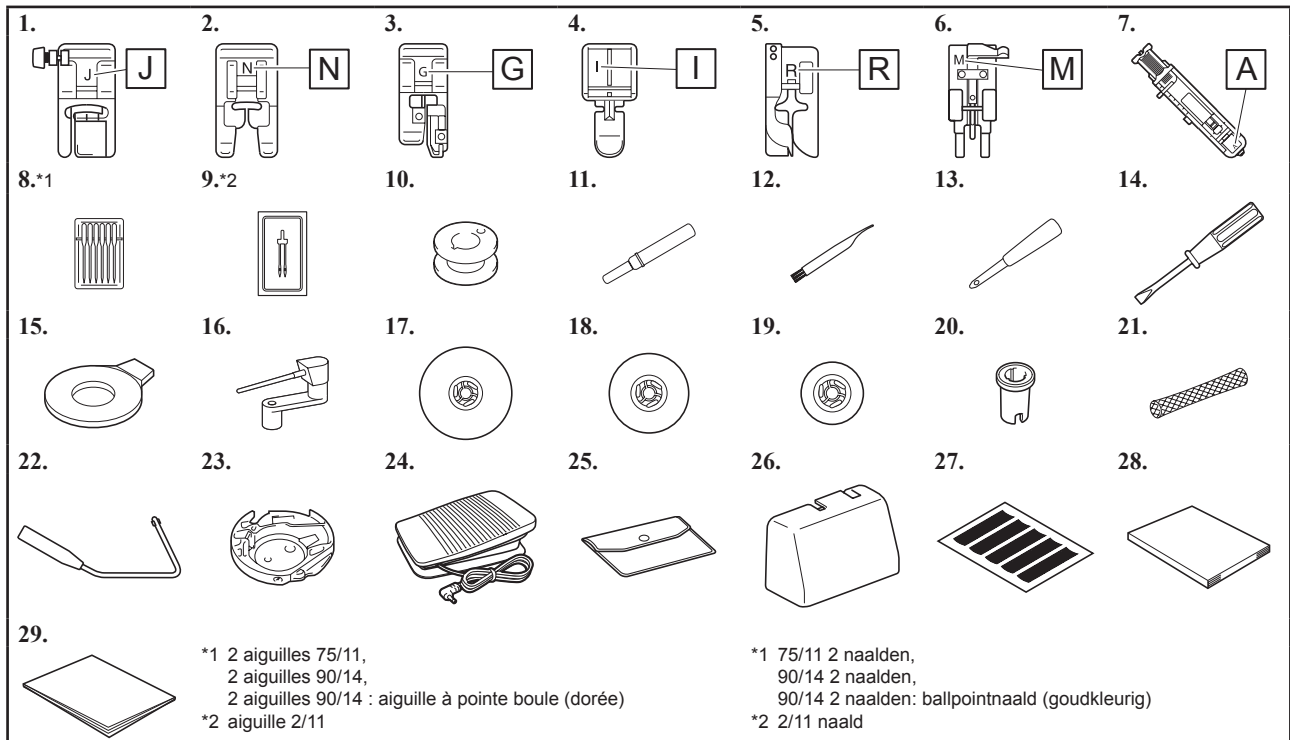

◆ Accessoires en option ◆ Optionele accessoires

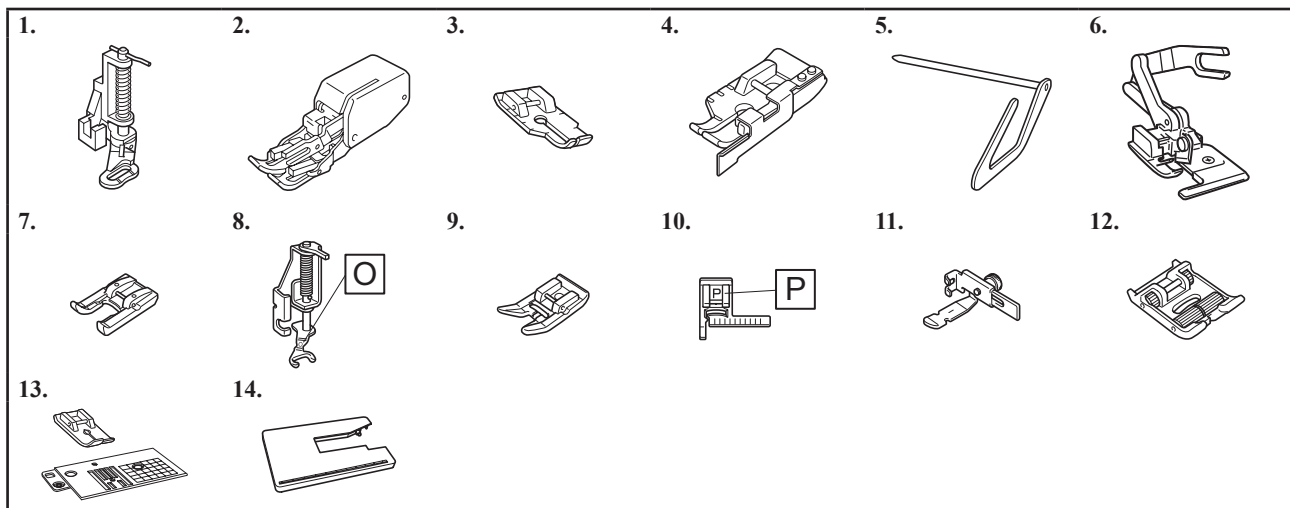

Remarque

- La vis du support du pied-de-biche est disponible auprès de votre revendeur Brother agréé. (code de référence: XG1343-001)
- Le tiroir d'accessoires pour pied-de-biche est disponible auprès de votre revendeur Brother agréé. (code de référence: XF8650-001)



Opmerking

- De persvoethouderschroef is verkrijgbaar via uw erkende Brother-dealer. (onderdeelcode: XG1343-001)
- Het opbergvak voor persvoeten is verkrijgbaar via uw erkende Brother-dealer. (onderdeelcode: XF8650-001)

◆ Accessoires inclus

| N° | Nom de la pièce | Code de la pièce | |
|----|---|---------------------|---|
| | | Continent américain | Autres |
| 1 | Pied zigzag « J » (sur la machine) | | XF3022-001 |
| 2 | Pied pour monogrammes « N » | | XD0810-031 |
| 3 | Pied pour faufilage « G » | | XC3098-031 |
| 4 | Pied pour fermetures à glissière « I » | | X59370-021 |
| 5 | Pied pour point invisible « R » | | XE2650-001 |
| 6 | Pied pour boutons « M » | | XE2643-001 |
| 7 | Pied pour boutonnières « A » | | XC2691-023 |
| 8 | Jeu d'aiguilles | | X58358-021 |
| 9 | Aiguille jumelée | | X59296-121 |
| 10 | Canette (4) (L'une se trouve sur la machine.) | SA156*3 | SFB: XA5539-151 |
| 11 | Découreur | | XF4967-001 |
| 12 | Brosse de nettoyage | | X59476-051 |
| 13 | Perce-œillet | | XZ5051-001 |
| 14 | Tournevis | | XC8349-021 |
| 15 | Tournevis en forme de disque | | XC1074-051 |
| 16 | Porte-bobine horizontal | | XC4654-251 |
| 17 | Couvercle de bobine (grand) | | 130012-024 |
| 18 | Couvercle de bobine (moyen) x 2 (L'un se trouve sur la machine.) | | XE1372-001 |
| 19 | Couvercle de bobine (petit) | | 130013-124 |
| 20 | Centre amovible pour bobine de fil (bobine de fil mini/très grande) | | XA5752-121 |
| 21 | Filet de la bobine | | XA5523-020 |
| 22 | Genouillère | | XA6941-052 |
| 23 | Boîtier de la canette (sur la machine) | | XG2058-001 |
| 24 | Pédale | | XZ5098-001 (zone UE) XZ5100-001 (autres zones) |
| 25 | Sac d'accessoires | | XC4487-021 |
| 26 | Protection rigide | | XG5628-001 |
| 27 | Ensemble de feuilles quadrillées | | XC4549-020 |
| 28 | Manuel d'instructions | | Contactez votre revendeur |
| 29 | Guide de référence rapide | | Brother agréé. |

*3 SA156 est une canette de catégorie 15.

◆ Bijgeleverde accessoires

| Nr. | Onderdeel | Onderdeelcode | |
|-----|---|---------------------------|--|
| | | Het Amerikaanse continent | Overige regio's |
| 1 | Zigzagvoet "J" (op machine) | | XF3022-001 |
| 2 | Monogramvoet "N" | | XD0810-031 |
| 3 | Afwerksteekvoet "G" | | XC3098-031 |
| 4 | Ritsvoet "I" | | X59370-021 |
| 5 | Blindzoomvoet "R" | | XE2650-001 |
| 6 | Knoopaanzetvoet "M" | | XE2643-001 |
| 7 | Knoopsgatvoet "A" | | XC2691-023 |
| 8 | Naaldsetje | | X58358-021 |
| 9 | Tweelingnaald | | X59296-121 |
| 10 | Spoel x 4 (één spoel is in de machine geplaatst.) | SA156*3 | SFB: XA5539-151 |
| 11 | Tommesje | | XF4967-001 |
| 12 | Schoonmaakborsteltje | | X59476-051 |
| 13 | Gaatjesponser | | XZ5051-001 |
| 14 | Schroevendraaier | | XC8349-021 |
| 15 | Schijfvormige schroevendraaier | | XC1074-051 |
| 16 | Horizontale klossen | | XC4654-251 |
| 17 | Kloshouder (groot) | | 130012-024 |
| 18 | Kloshouder (medium) x 2 (één spoel is in de machine geplaatst.) | | XE1372-001 |
| 19 | Kloshouder (klein) | | 130013-124 |
| 20 | Garenklos hulpinzet (bij mini- of kingsize garenklos) | | XA5752-121 |
| 21 | Klosnetje | | XA5523-020 |
| 22 | Kniehevel | | XA6941-052 |
| 23 | Spoelhuis (op de machine geplaatst) | | XG2058-001 |
| 24 | Voetpedaal | | XZ5098-001 (EU) XZ5100-001 (andere regio's) |
| 25 | Accessoires tasje | | XC4487-021 |
| 26 | Koffer | | XG5628-001 |
| 27 | Rasterzet | | XC4549-020 |
| 28 | Bedieningshandleiding | | Neem contact op met uw erkende Brother-dealer. |
| 29 | Beknopte bedieningshandleiding | | |

*3 SA156 is een spoeltype van klasse 15.

◆ Accessoires en option

Les éléments suivants sont des accessoires en option vendus séparément par votre revendeur Brother agréé.

| N° | Nom de la pièce | Code de la pièce | |
|----|---|--------------------------|--|
| | | Continent américain | Autres |
| 1 | Pied pour quilting (courtepointe) | SA129 | F005N: XC1948-052 |
| 2 | Pied à double entraînement | SA140 | F033N: XC2214-052 |
| 3 | Pied pour quilting (courtepointe) 1/4" / pouce | SA125 | F001N: XC1944-052 |
| 4 | Guide et pied pour quilting (courtepointe) 1/4" / pouce | SA185 | F057: XC7416-252 |
| 5 | Guide pour quilting (courtepointe) | SA132 | F016N: XC2215-052 |
| 6 | Couteau raseur « S » | SA177 | F054: XC3879-152 |
| 7 | Pied ouvert | SA186 | F060: XE1094-101 |
| 8 | Pied pour quilting (courtepointe) ouvert en mouvement libre « O » | SA187 | F061: XE1097-001 |
| 9 | Pied-de-biche non adhérent | SA114 | F007N: XC1949-052 |
| 10 | Pied-de-biche de guidage de points « P » | SA160 | F035N: XC1969-052 |
| 11 | Pied réglable pour fermetures à glissière/passepoils | SA161 | F036N: XC1970-052 |
| 12 | Pied à rouleau | SA190 | F066: XF1723-001 |
| 13 | Ensemble pied pour point droit et plaque d'aiguille | SA564 SA564C (Canada) | SNP02: XG0946-001 SNP02AP: XG0948-001 |
| 14 | Grande table d'extension | SAWT4 | WT14: XG5051-001 WT14AP: XG4656-001 |

◆ Optionele accessoires

Optionele accessoires, apart verkrijgbaar bij uw officiële Brother dealer.

| Nr. | Onderdeel | Onderdeelcode | |
|-----|--|---------------------------|--|
| | | Het Amerikaanse continent | Overige regio's |
| 1 | Quiltvoet | SA129 | F005N: XC1948-052 |
| 2 | Boventransportvoet | SA140 | F033N: XC2214-052 |
| 3 | 1/4-inch quiltvoet | SA125 | F001N: XC1944-052 |
| 4 | 1/4-inch quiltvoet met geleider | SA185 | F057: XC7416-252 |
| 5 | Quiltgeleider | SA132 | F016N: XC2215-052 |
| 6 | Zijnsnijder "S" | SA177 | F054: XC3879-152 |
| 7 | Open voet | SA186 | F060: XE1094-101 |
| 8 | Open quiltvoet "O" voor naaien uit de vrije hand | SA187 | F061: XE1097-001 |
| 9 | Gladde transportvoet | SA114 | F007N: XC1949-052 |
| 10 | Steekgeleidervoet "P" | SA160 | F035N: XC1969-052 |
| 11 | Verstelbare ritsvoet / paspelvoet | SA161 | F036N: XC1970-052 |
| 12 | Rolvoet | SA190 | F066: XF1723-001 |
| 13 | Rechte-steekvoet en naaldplaatset | SA564 SA564C (Canada) | SNP02: XG0946-001 SNP02AP: XG0948-001 |
| 14 | Groot werkblad | SAWT4 | WT14: XG5051-001 WT14AP: XG4656-001 |

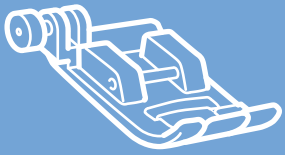

Accessori

Accesorios

◆ Accessori in dotazione ◆ Accesorios incluidos

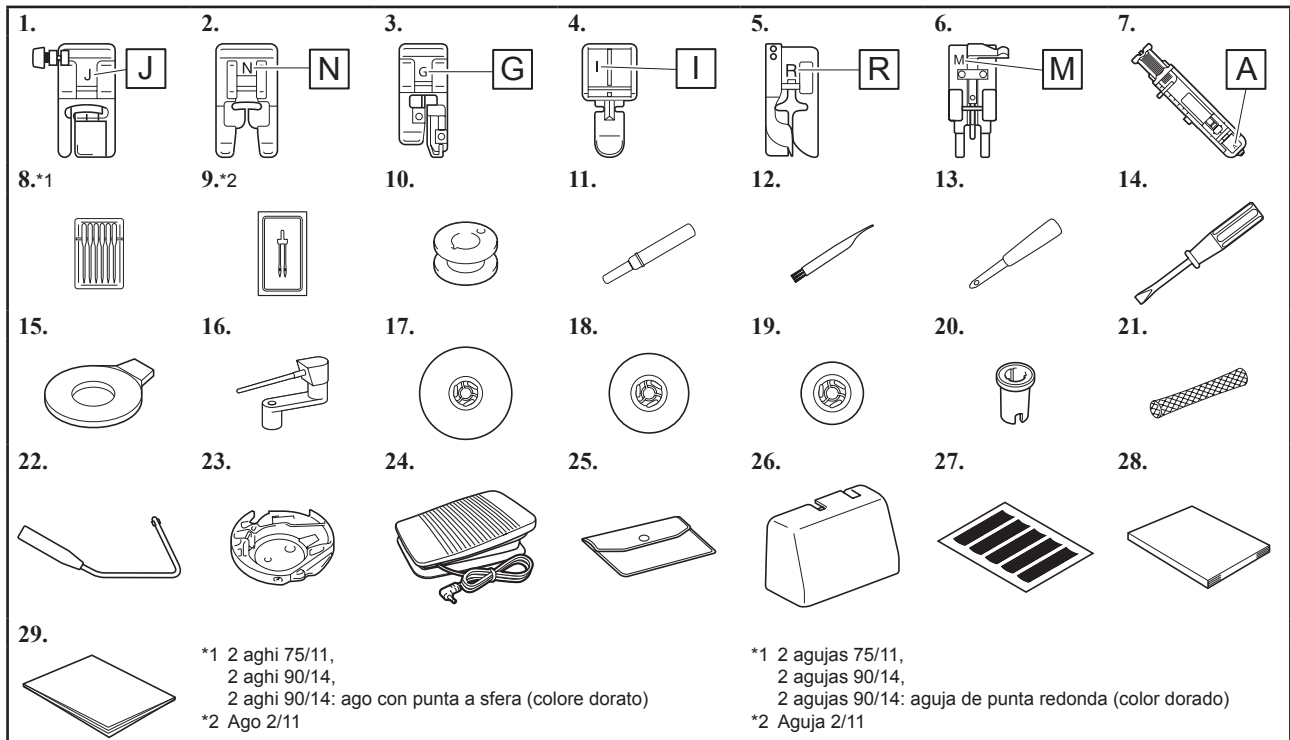

◆ Accessori opzionali ◆ Accesorios opcionales

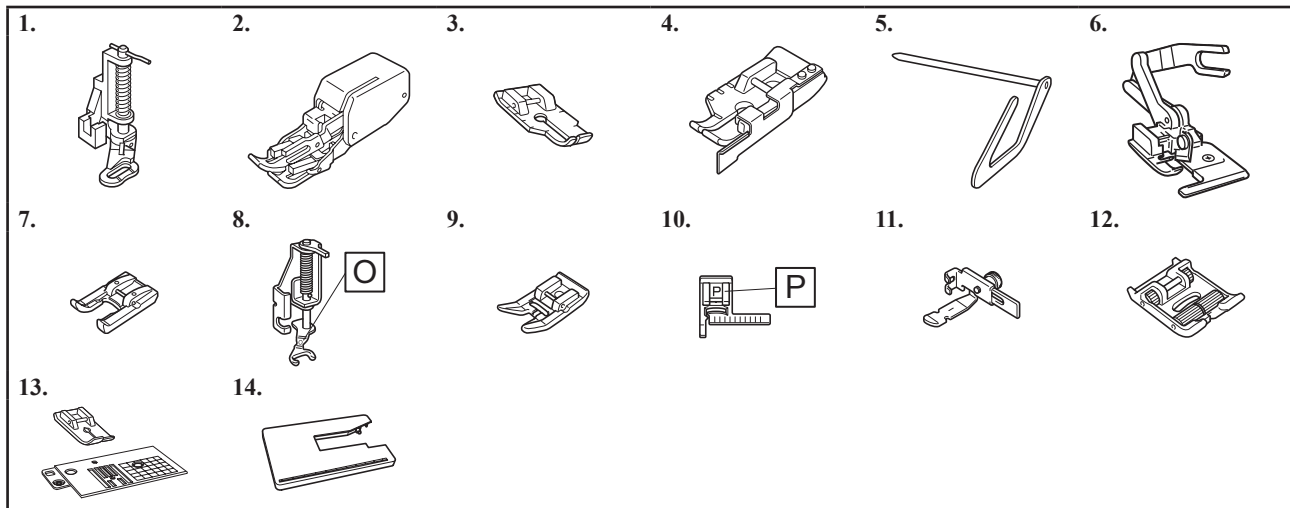

Nota

- La vite del supporto del piedino premistoffa è disponibile presso il proprio rivenditore Brother autorizzato. (Codice parte: XG1343-001)
- Il vano accessori per piedini premistoffa è disponibile presso il proprio rivenditore Brother autorizzato. (Codice parte: XF8650-001)



Nota

- Puede adquirir el tornillo del soporte del pie prensatela en su distribuidor autorizado Brother. (Referencia: XG1343-001)
- Puede adquirir la bandeja de accesorios del pie prensatela en su distribuidor Brother autorizado. (Referencia: XF8650-001)

◆ Accessori in dotazione

| N° | Nome parte | Codice parte | |
|----|---|--|-----------------|
| | | Americhe | Varie |
| 1 | Piedino per zig-zag "J" (sulla macchina) | XF3022-001 | |
| 2 | Piedino per monogrammi "N" | XD0810-031 | |
| 3 | Piedino per sopraffitto "G" | XC3098-031 | |
| 4 | Piedino per cerniere "I" | X59370-021 | |
| 5 | Piedino per punto invisibile "R" | XE2650-001 | |
| 6 | Piedino di cucitura bottone "M" | XE2643-001 | |
| 7 | Piedino per asole "A" | XC2691-023 | |
| 8 | Set di aghi | X58358-021 | |
| 9 | Ago gemello | X59296-121 | |
| 10 | Spolina (4) (una è sulla macchina.) | SA156*3 | SFB: XA5539-151 |
| 11 | Taglia asole | XF4967-001 | |
| 12 | Spazzolino di pulizia | X59476-051 | |
| 13 | Punzone per occhiali | XZ5051-001 | |
| 14 | Cacciavite | XC8349-021 | |
| 15 | Cacciavite a disco | XC1074-051 | |
| 16 | Portarocchetto orizzontale | XC4654-251 | |
| 17 | Fermo per rocchetto (grande) | 130012-024 | |
| 18 | Fermo per rocchetto (medio) (2) (uno è sulla macchina.) | XE1372-001 | |
| 19 | Fermo per rocchetto (piccolo) | 130013-124 | |
| 20 | Inserito per rocchetto di filo (rocchetto di filo mini-extra large) | XA5752-121 | |
| 21 | Retina | XA5523-020 | |
| 22 | Ginocchiera alzapiedino | XA6941-052 | |
| 23 | Cestello della spolina (sulla macchina) | XG2058-001 | |
| 24 | Pedale reostato | XZ5098-001 (area UE) XZ5100-001 (altre aree) | |
| 25 | Borsa accessori | XC4487-021 | |
| 26 | Custodia rigida | XG5628-001 | |
| 27 | Set di fogli millimetrati | XC4549-020 | |
| 28 | Manuale di istruzioni | Contattare il proprio rivenditore Brother autorizzato. | |
| 29 | Guida di riferimento rapido | Contattare il proprio rivenditore Brother autorizzato. | |

*3 SA156 è una spolina del tipo Classe 15.

◆ Accesorios incluidos

| N° | Nombre de la pieza | Código de la pieza | |
|----|---|---|-----------------|
| | | América | Otros |
| 1 | Pie para zig-zag "J" (en la máquina) | XF3022-001 | |
| 2 | Pie para monogramas "N" | XD0810-031 | |
| 3 | Pie para sobrehilado "G" | XC3098-031 | |
| 4 | Pie para cremalleras "I" | X59370-021 | |
| 5 | Pie para puntada invisible "R" | XE2650-001 | |
| 6 | Pie especial para botones "M" | XE2643-001 | |
| 7 | Pie para ojales "A" | XC2691-023 | |
| 8 | Juego de agujas | X58358-021 | |
| 9 | Aguja gemela | X59296-121 | |
| 10 | Bobina (4) (Una está colocada en la máquina.) | SA156*3 | SFB: XA5539-151 |
| 11 | Abreojales | XF4967-001 | |
| 12 | Cepillo de limpieza | X59476-051 | |
| 13 | Lápiz calador | XZ5051-001 | |
| 14 | Destornillador | XC8349-021 | |
| 15 | Destornillador de disco | XC1074-051 | |
| 16 | Portacarrete horizontal | XC4654-251 | |
| 17 | Tapa del carrete (grande) | 130012-024 | |
| 18 | Tapa del carrete (mediana) (2) (Una está colocada en la máquina.) | XE1372-001 | |
| 19 | Tapa de carrete (pequeña) | 130013-124 | |
| 20 | Inserción del carrete de hilo (carrete de hilo "mini king") | XA5752-121 | |
| 21 | Red para carrete | XA5523-020 | |
| 22 | Elevador de rodilla | XA6941-052 | |
| 23 | Caja de la bobina (en la máquina) | XG2058-001 | |
| 24 | Pedal | XZ5098-001 (zona de la UE) XZ5100-001 (otras zonas) | |
| 25 | Bolsa de accesorios | XC4487-021 | |
| 26 | Estuche protector | XG5628-001 | |
| 27 | Juego de hojas cuadrículadas | XC4549-020 | |
| 28 | Manual de instrucciones | Póngase en contacto con su distribuidor Brother autorizado. | |
| 29 | Guía de referencia rápida | Póngase en contacto con su distribuidor Brother autorizado. | |

*3 SA156 Es de bobina clase tipo 15.

◆ Accessori opzionali

Di seguito si elencano i componenti disponibili come accessori opzionali da acquistare separatamente presso il proprio rivenditore Brother autorizzato.

| N° | Nome parte | Codice parte | |
|----|---|--------------------------|--|
| | | Americhe | Varie |
| 1 | Piedino per trapuntatura | SA129 | F005N: XC1948-052 |
| 2 | Piedino doppio trasporto | SA140 | F033N: XC2214-052 |
| 3 | Piedino per trapuntatura da 1/4" | SA125 | F001N: XC1944-052 |
| 4 | Piedino per trapuntatura da 1/4" con guida | SA185 | F057: XC7416-252 |
| 5 | Guida per trapuntatura | SA132 | F016N: XC2215-052 |
| 6 | Taglierina laterale "S" | SA177 | F054: XC3879-152 |
| 7 | Piedino a punta aperta | SA186 | F060: XE1094-101 |
| 8 | Piedino a punta aperta per trapuntatura a mano libera "O" | SA187 | F061: XE1097-001 |
| 9 | Piedino antiaderente | SA114 | F007N: XC1949-052 |
| 10 | Piedino guida punto "P" | SA160 | F035N: XC1969-052 |
| 11 | Piedino regolabile per cerniere/cordoncino | SA161 | F036N: XC1970-052 |
| 12 | Piedino a rullo | SA190 | F066: XF1723-001 |
| 13 | Set piedino e placca ago per punto diritto | SA564 SA564C (Canada) | SNP02: XG0946-001 SNP02AP: XG0948-001 |
| 14 | Tavola ampia | SAWT4 | WT14: XG5051-001 WT14AP: XG4656-001 |

◆ Accesorios opcionales

En la tabla siguiente se presentan los accesorios opcionales disponibles que pueden adquirirse por separado en un distribuidor de Brother autorizado.

| N° | Nombre de la pieza | Código de la pieza | |
|----|--|--------------------------|--|
| | | América | Otros |
| 1 | Pie para acolchados | SA129 | F005N: XC1948-052 |
| 2 | Pie móvil | SA140 | F033N: XC2214-052 |
| 3 | Pie para acolchado de 1/4" | SA125 | F001N: XC1944-052 |
| 4 | Pie para acolchado de 1/4" con guía | SA185 | F057: XC7416-252 |
| 5 | Guía de acolchados | SA132 | F016N: XC2215-052 |
| 6 | Cuchilla lateral "S" | SA177 | F054: XC3879-152 |
| 7 | Pie de punta abierta | SA186 | F060: XE1094-101 |
| 8 | Pie para acolchado libre de punta abierta "O" | SA187 | F061: XE1097-001 |
| 9 | Pie antiaderente | SA114 | F007N: XC1949-052 |
| 10 | Pie para guía de puntadas "P" | SA160 | F035N: XC1969-052 |
| 11 | Pie ajustable para cremalleras/ribetes | SA161 | F036N: XC1970-052 |
| 12 | Pie de rodillo | SA190 | F066: XF1723-001 |
| 13 | Pie de costura recta y juego de placas de la aguja | SA564 SA564C (Canada) | SNP02: XG0946-001 SNP02AP: XG0948-001 |
| 14 | Tabla ancha | SAWT4 | WT14: XG5051-001 WT14AP: XG4656-001 |

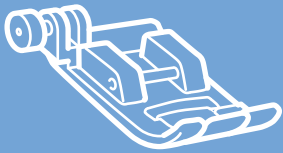

Acessórios

Принадлежности

◆ Acessórios incluídos ◆ Принадлежности в комплекте поставки

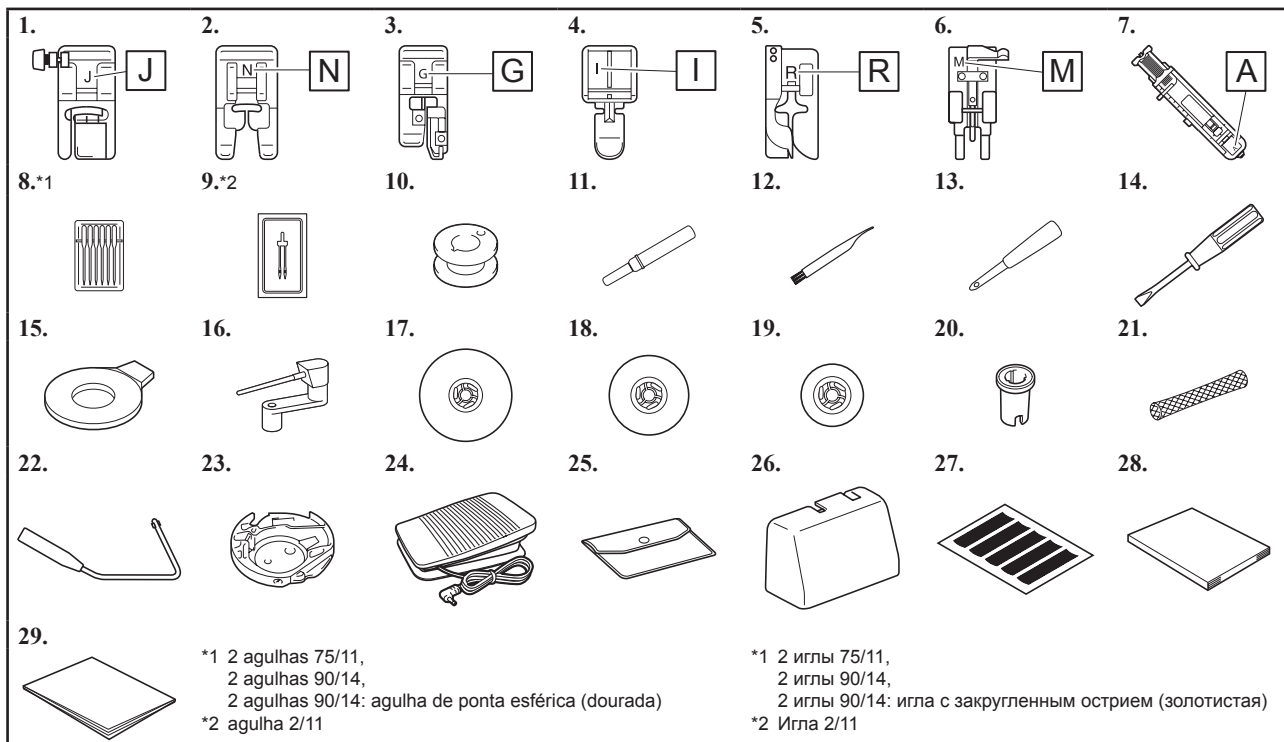

◆ Acessórios opcionais ◆ Дополнительные принадлежности

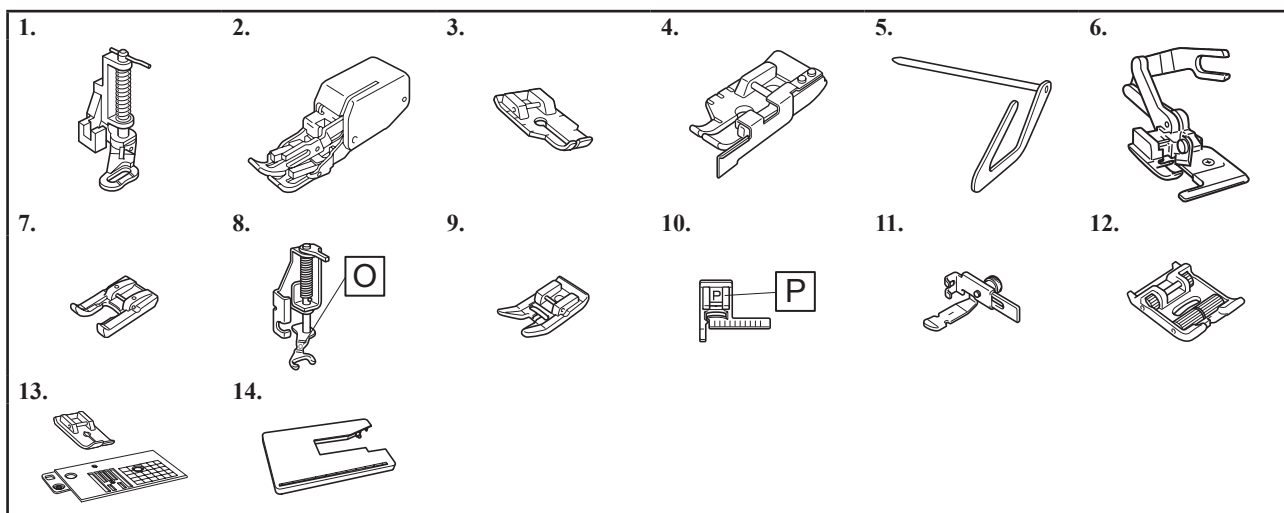

Nota

- O parafuso do suporte do pé-calçador está disponível com o seu revendedor autorizado da Brother. (Código da peça: XG1343-001)
- A bandeja acessória do pé-calçador está disponível com o seu revendedor autorizado da Brother. (Código da peça: XF8650-001)



Примечание

- Винт держателя прижимной лапки можно приобрести у официального дилера Brother. (номер по каталогу: XG1343-001)
- Ящик для прижимных лапок можно приобрести у официального дилера Brother. (номер по каталогу: XF8650-001).

◆ Acessórios incluídos

| N° | Nome da peça | Código da peça | |
|----|--|---|-----------------|
| | | Américas | Outros |
| 1 | Calçador de zigue-zague "J" (na máquina) | | XF3022-001 |
| 2 | Calçador de monograma "N" | | XD0810-031 |
| 3 | Calçador de chuleado "G" | | XC3098-031 |
| 4 | Calçador de zíper "I" | | X59370-021 |
| 5 | Calçador de ponto invisível "R" | | XE2650-001 |
| 6 | Calçador de pregar de botão "M" | | XE2643-001 |
| 7 | Calçador de casear botão "A" | | XC2691-023 |
| 8 | Conjunto de agulhas | | X58358-021 |
| 9 | Agulha dupla | | X59296-121 |
| 10 | Bobina (4) (Uma está na máquina.) | SA156*3 | SFB: XA5539-151 |
| 11 | Abridor de costura | | XF4967-001 |
| 12 | Escova de limpeza | | X59476-051 |
| 13 | Perfurador de ilhó | | XZ5051-001 |
| 14 | Chave de fenda | | XC8349-021 |
| 15 | Chave de fenda em forma de disco | | XC1074-051 |
| 16 | Porta-carretel horizontal | | XC4654-251 |
| 17 | Tampa do carretel (grande) | | 130012-024 |
| 18 | Tampa do carretel (média) (2) (Uma está na máquina.) | | XE1372-001 |
| 19 | Tampa do carretel (pequena) | | 130013-124 |
| 20 | Inserto do carretel (minicarretel principal) | | XA5752-121 |
| 21 | Redinha do carretel | | XA5523-020 |
| 22 | Joelheira | | XA6941-052 |
| 23 | Caixa da bobina (na máquina) | | XG2058-001 |
| 24 | Pedal | XZ5098-001(Região da UE) XZ5100-001(outras regiões) | |
| 25 | Bolsa de acessórios | | XC4487-021 |
| 26 | Estojo rígido | | XG5628-001 |
| 27 | Conjunto de folhas de gabarito | | XC4549-020 |
| 28 | Manual de Operações | Entre em contato com o seu revendedor autorizado Brother. | |
| 29 | Guia de referência rápida | | |

*3 SA156 é um tipo de bobina da classe 15.

◆ Acessórios opcionais

Os acessórios a seguir são opcionais e devem ser adquiridos separadamente em um revendedor autorizado da Brother.

| N° | Nome da peça | Código da peça | |
|----|---|--------------------------|--|
| | | Américas | Outros |
| 1 | Calçador de acolchoado | SA129 | F005N: XC1948-052 |
| 2 | Calçador de transporte duplo | SA140 | F033N: XC2214-052 |
| 3 | Calçador de acolchoado 1/4" | SA125 | F001N: XC1944-052 |
| 4 | Calçador de acolchoado 1/4" com guia | SA185 | F057: XC7416-252 |
| 5 | Guia de acolchoado | SA132 | F016N: XC2215-052 |
| 6 | Cortador lateral em "S" | SA177 | F054: XC3879-152 |
| 7 | Calçador aberto | SA186 | F060: XE1094-101 |
| 8 | Calçador aberto de movimento livre para acolchoados "O" | SA187 | F061: XE1097-001 |
| 9 | Calçador antiaderente | SA114 | F007N: XC1949-052 |
| 10 | Calçador de guia de ponto "P" | SA160 | F035N: XC1969-052 |
| 11 | Calçador ajustável de zíper/vivo | SA161 | F036N: XC1970-052 |
| 12 | Calçador com rolete | SA190 | F066: XF1723-001 |
| 13 | Conjunto de calçador de ponto reto e chapa de agulha | SA564 SA564C (Canadá) | SNP02: XG0946-001 SNP02AP: XG0948-001 |
| 14 | Mesa extensora | SAWT4 | WT14: XG5051-001 WT14AP: XG4656-001 |

◆ Pertencimentos em conjunto de entrega

| № | Наименование | Код изделия | |
|----|--|---|-----------------|
| | | Америка | Другие |
| 1 | Лапка для строчки зигзаг "J" (установлена на машине) | | XF3022-001 |
| 2 | Лапка для выстрачивания монограмм "N" | | XD0810-031 |
| 3 | Лапка для краеобметочных работ "G" | | XC3098-031 |
| 4 | Лапка для вшивания "молнии" "I" | | X59370-021 |
| 5 | Лапка для потайной строчки "R" | | XE2650-001 |
| 6 | Лапка для пришивания пуговиц "M" | | XE2643-001 |
| 7 | Лапка для обметывания петель "A" | | XC2691-023 |
| 8 | Набор игл | | X58358-021 |
| 9 | Двойная игла | | X59296-121 |
| 10 | Шпулька (4 шт.) (одна из них установлена на машине.) | SA156*3 | SFB: XA5539-151 |
| 11 | Вспарыватель для петель | | XF4967-001 |
| 12 | Щеточка для очистки | | X59476-051 |
| 13 | Прошивка | | XZ5051-001 |
| 14 | Отвертка | | XC8349-021 |
| 15 | Дискообразная отвертка | | XC1074-051 |
| 16 | Горизонтальный стержень для установки катушки | | XC4654-251 |
| 17 | Колпачок катушки (большой) | | 130012-024 |
| 18 | Колпачок катушки (средний) (2 шт.) (один из них установлен на машине.) | | XE1372-001 |
| 19 | Колпачок катушки (малый) | | 130013-124 |
| 20 | Вставка для катушки с нитью (катушки Mini-King) | | XA5752-121 |
| 21 | Сетка для катушки | | XA5523-020 |
| 22 | Коленоподъемник | | XA6941-052 |
| 23 | Шпульный колпачок (установлен на машине) | | XG2058-001 |
| 24 | Педаль | XZ5098-001 (для ЕС), XZ5100-001 (другие регионы) | |
| 25 | Сумка для принадлежностей | | XC4487-021 |
| 26 | Жесткий футляр | | XG5628-001 |
| 27 | Комплект листов с координатной сеткой | | XC4549-020 |
| 28 | Руководство пользователя | Обратитесь к официальному дилеру Brother. | |
| 29 | Краткий справочник | | |

*3 SA156 представляет собой шпульку типа Class15.

◆ Дополнительные принадлежности

Перечисленные ниже дополнительные принадлежности можно приобрести отдельно у официального дилера Brother.

| № | Наименование | Код изделия | |
|----|---|------------------------------|--|
| | | Америка | Другие |
| 1 | Стегальная лапка | SA129 | F005N: XC1948-052 |
| 2 | Шагающая лапка | SA140 | F033N: XC2214-052 |
| 3 | Стегальная лапка 1/4 дюйма | SA125 | F001N: XC1944-052 |
| 4 | Стегальная лапка 1/4 дюйма с направляющей | SA185 | F057: XC7416-252 |
| 5 | Направляющая для выстигивания | SA132 | F016N: XC2215-052 |
| 6 | Боковой нож "S" | SA177 | F054: XC3879-152 |
| 7 | Лапка с открытым мыском | SA186 | F060: XE1094-101 |
| 8 | Стегальная лапка с открытым мыском "O" для свободной подачи материала | SA187 | F061: XE1097-001 |
| 9 | Скользкая лапка | SA114 | F007N: XC1949-052 |
| 10 | Направляющая лапка "P" | SA160 | F035N: XC1969-052 |
| 11 | Регулируемая лапка для вшивания молнии/канта | SA161 | F036N: XC1970-052 |
| 12 | Роликовая лапка | SA190 | F066: XF1723-001 |
| 13 | Игольная пластина и прижимная лапка для прямострочных операций | SA564 SA564C (для Канады) | SNP02: XG0946-001 SNP02AP: XG0948-001 |
| 14 | Стол-приставка | SAWT4 | WT14: XG5051-001 WT14AP: XG4656-001 |



Bobbin Winding and Setting

Aufspulen des Unterfadens und Einstellung

Bobinage et réglage de la canette

Opwinden en instellen van de spoel

Avvolgimento spolina e caricamento

Bobinado y ajuste

Configuração e enrolamento da bobina

Намотка и установка шпульки

Follow the steps below in numerical order. Refer to the Operation Manual for detailed instructions.
 Führen Sie die folgenden Schritte in der numerischen Reihenfolge aus. Ausführliche Hinweise finden Sie in der Bedienungsanleitung.
 Respectez les étapes ci-dessous, dans l'ordre numérique. Reportez-vous au Manuel d'instructions pour des informations détaillées.
 Volg onderstaande stappen in numerieke volgorde. In de Bedieningshandleiding vindt u uitvoerige aanwijzingen.
 Seguire i passaggi di seguito, in ordine numerico. Per le istruzioni dettagliate, consultare il Manuale di istruzioni.
 Siga los pasos descritos a continuación, en orden numérico. Consulte las instrucciones detalladas en el Manual de instrucciones.
 Siga as etapas abaixo, em ordem numérica. Consulte o Manual de Operações para obter instruções detalhadas.
 Выполните описанные ниже действия по порядку номеров. Подробные инструкции см. в Руководстве пользователя.

Use only the included bobbin or bobbins of the same type.
 Verwenden Sie nur die im Lieferumfang enthaltene Spule oder Spulen vom selben Typ.
 N'utilisez que la canette fournie ou des canettes du même type.
 Gebruik uitsluitend de bijgeleverde spoel of spoelen van hetzelfde type.
 Utilizzare solo la bobina o le bobine in dotazione dello stesso tipo.
 Utilice solo la bobina incluida, o bobinas del mismo tipo.
 Somente use a bobina incluída ou bobinas do mesmo tipo.
 Используйте только прилагаемые шпульки или шпульки того же типа.

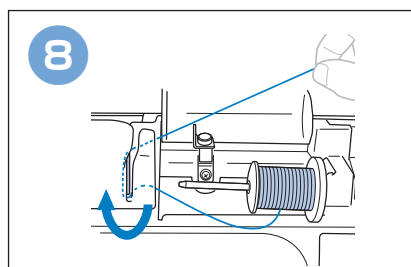
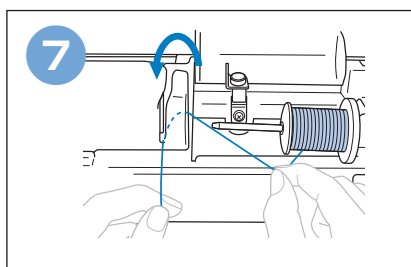
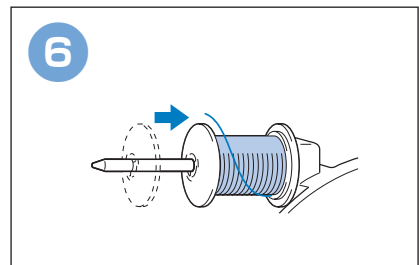
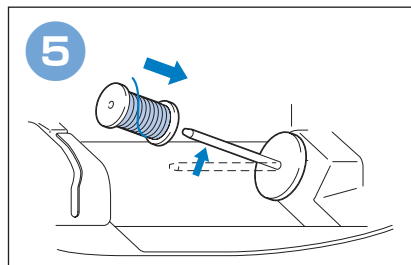
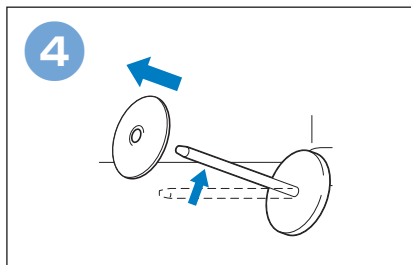
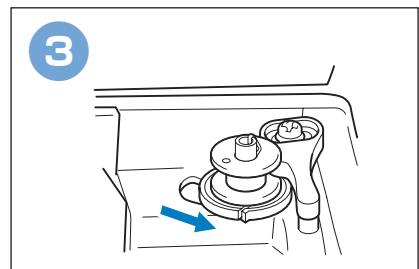
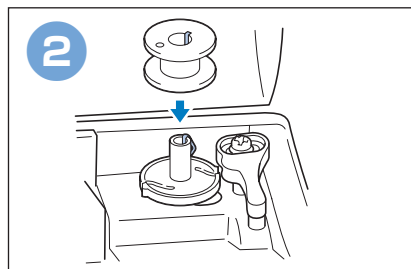
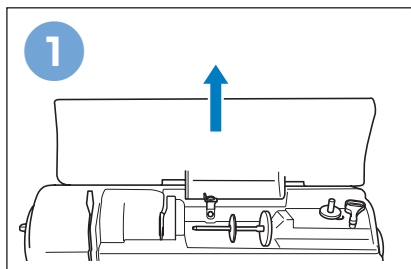
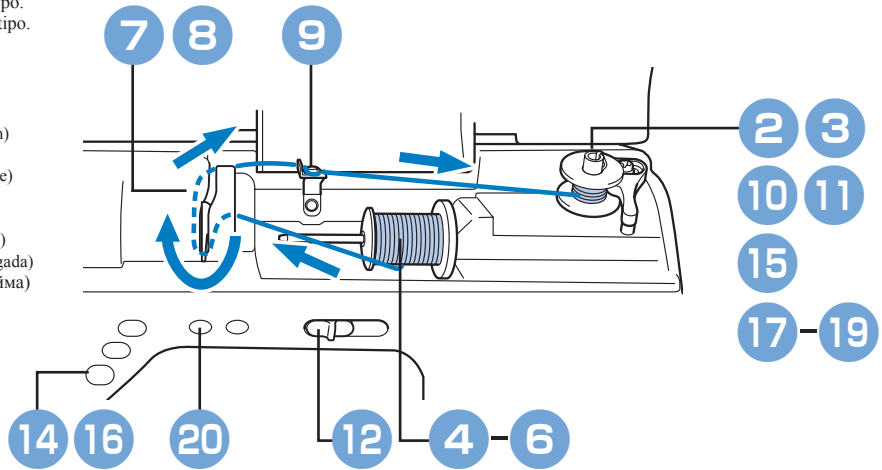
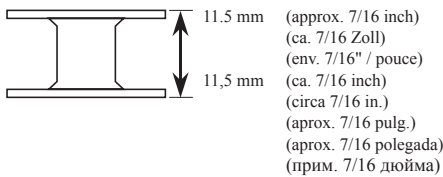

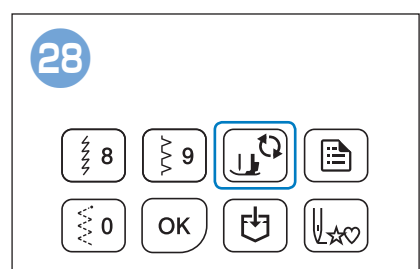
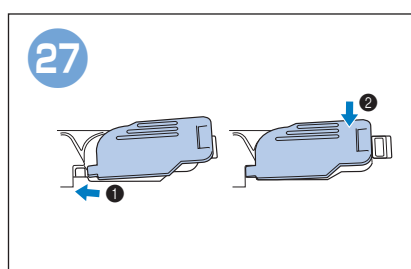
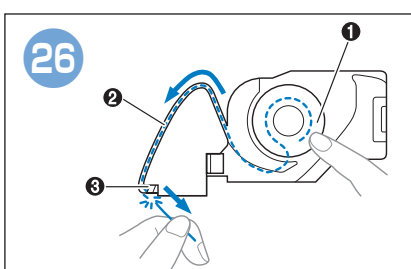
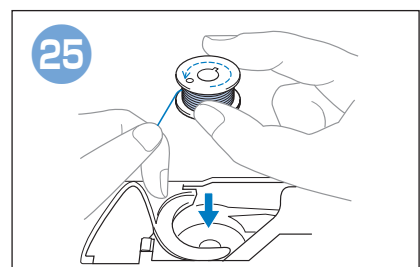
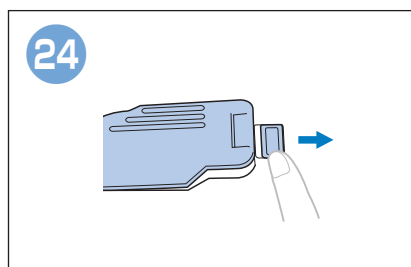
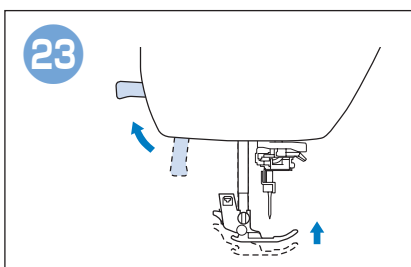
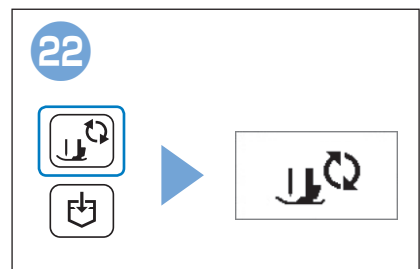
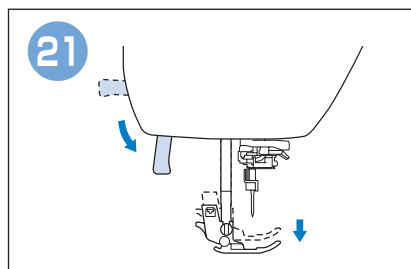
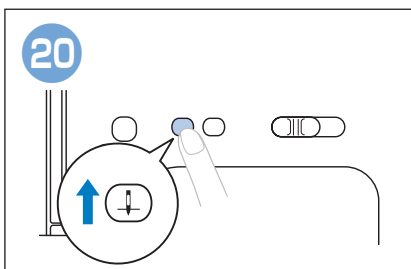
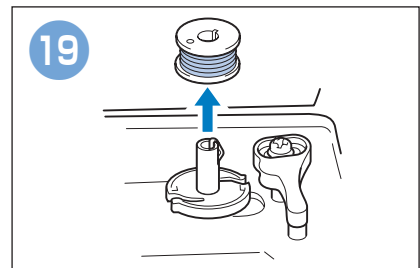
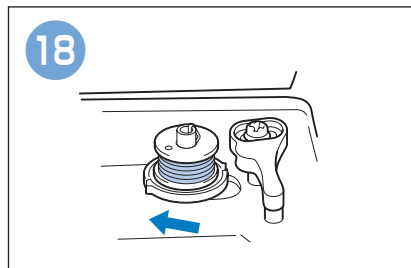
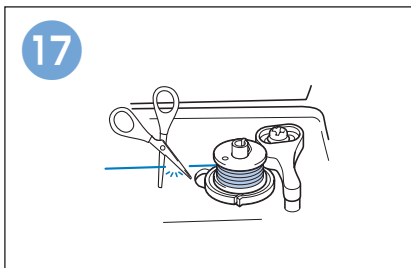
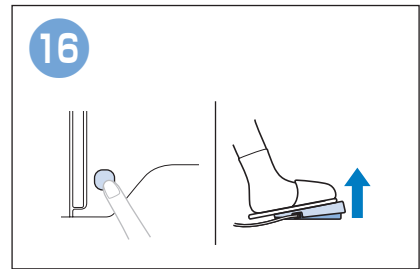
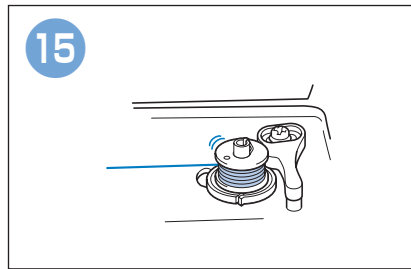
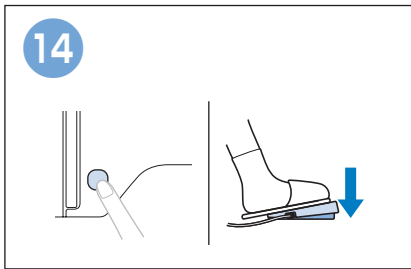
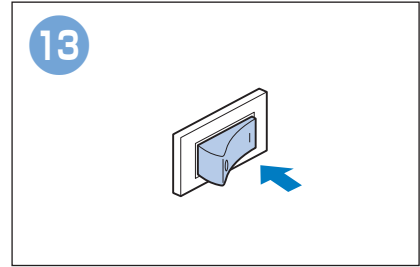
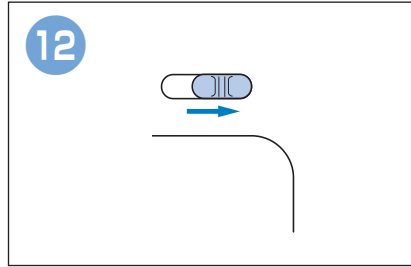
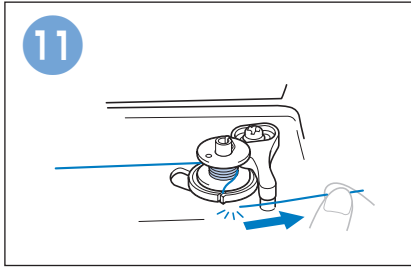
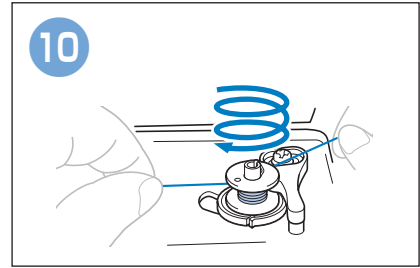
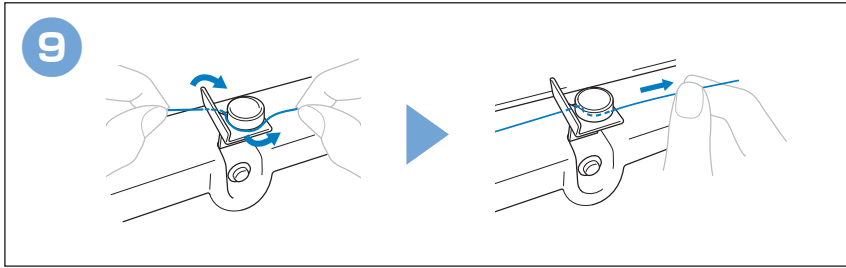

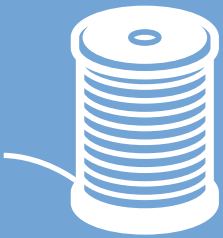

Upper Threading
Einfädeln des Oberfadens
Enfilage supérieur
Inrijgen van de bovendraad
Infilatura superiore
Hilo superior
Passagem da linha superior
Заправка верхней нити

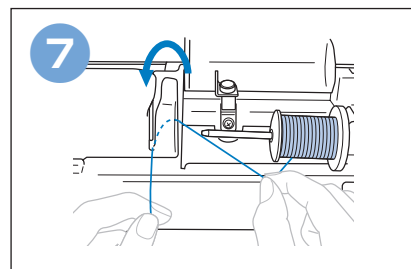
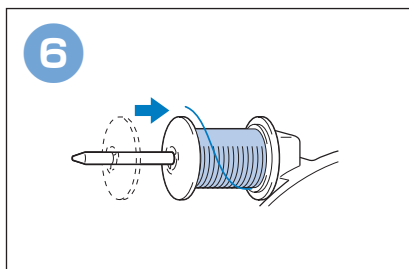
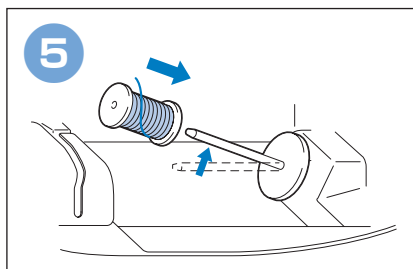
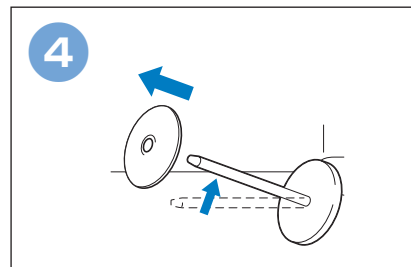
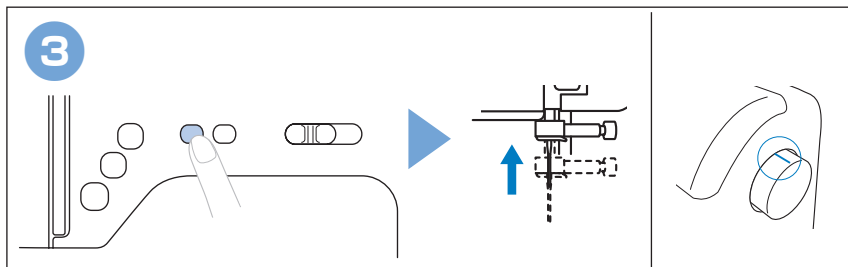
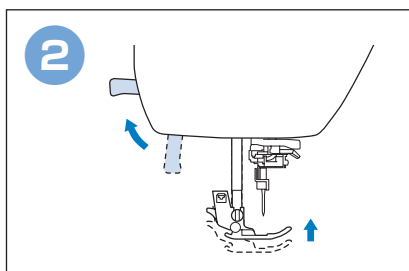
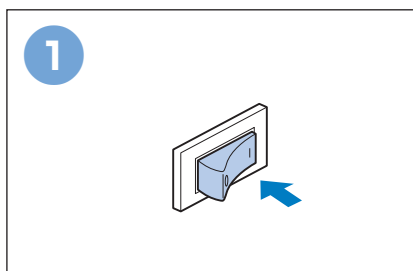
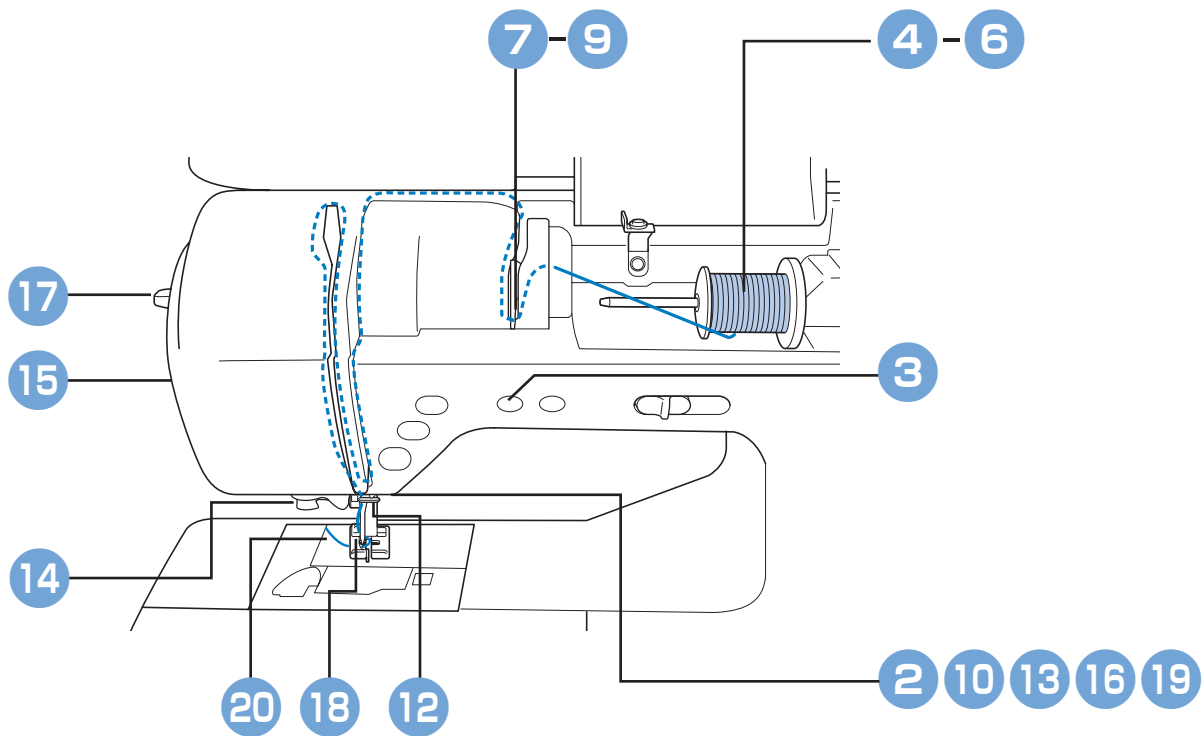

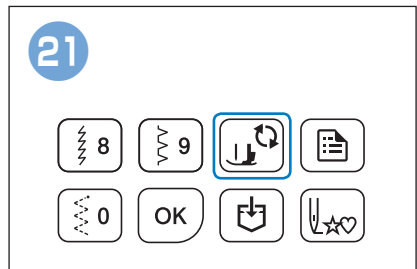
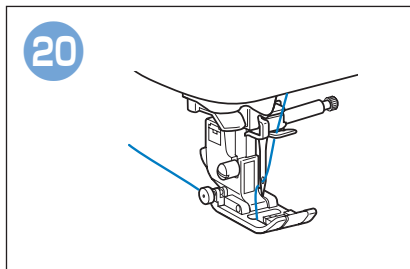
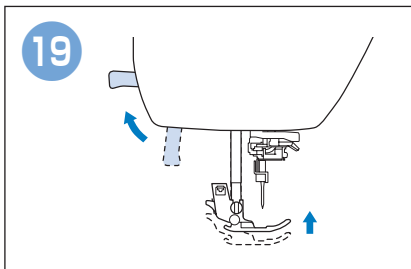
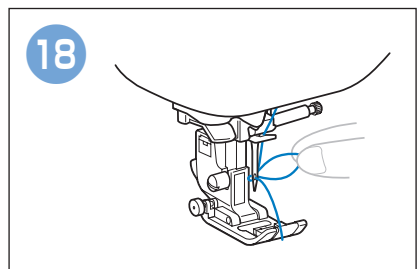
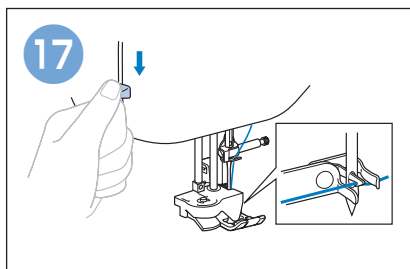
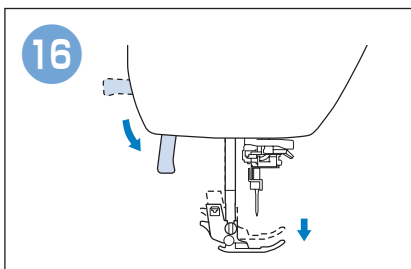
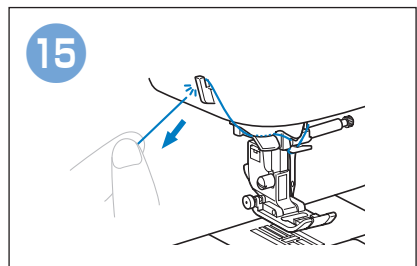
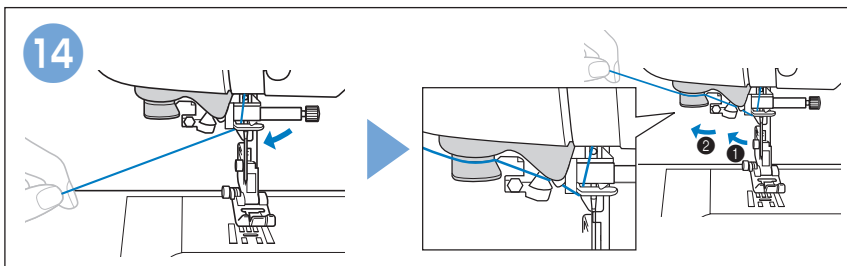
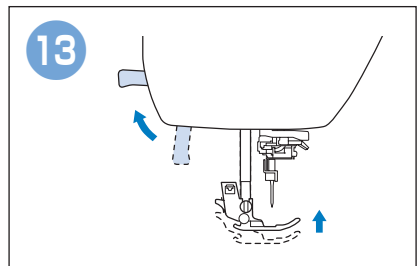
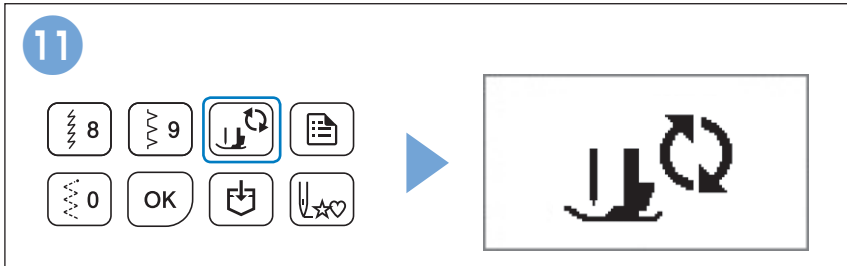
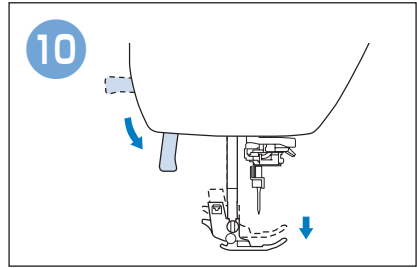
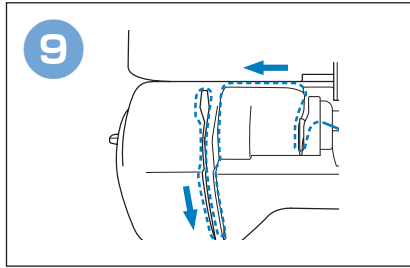
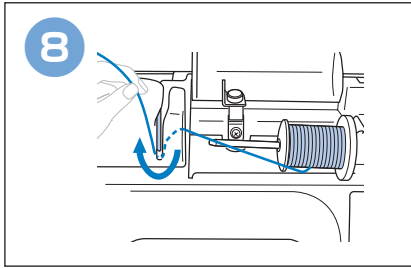



Selecting and Sewing Patterns
Auswählen und Nähen von Stichen
Sélection et couture de motifs
Steken selecteren en naaien
Selezione e cucitura di motivi
Seleccionar y coser patrones
Seleção e costura de padrões
Выбор швейных строчек

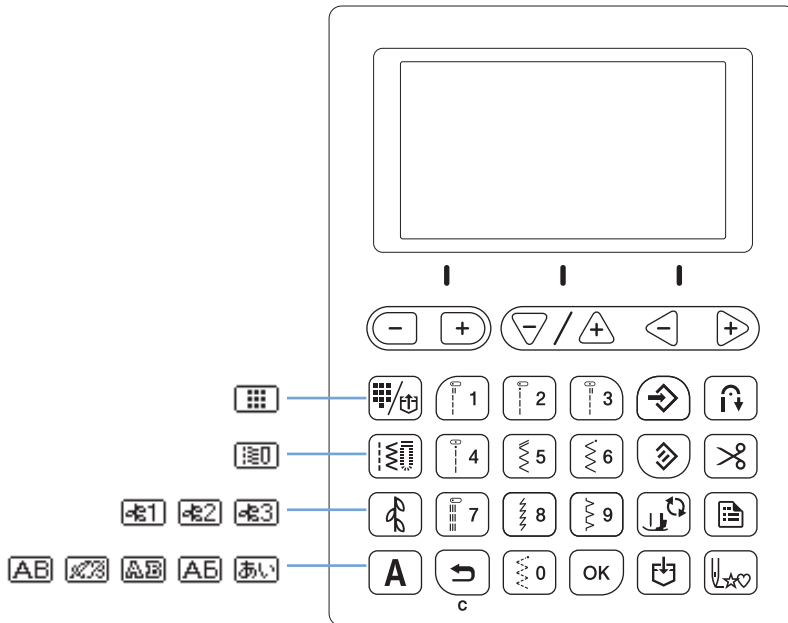

◆ Preset Utility Stitches
 ◆ Punti utili preimpostati

◆ Voreingestellte Nutztische
 ◆ Puntadas de utilidad predefinidas

◆ Préréglage des points de couture courants
 ◆ Pontos utilitários predefinidos

◆ Vooraf ingestelde naaisteken
 ◆ Предварительно заданные основные строчки

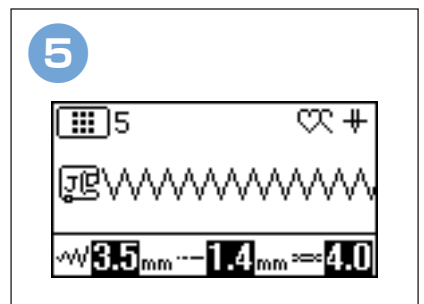
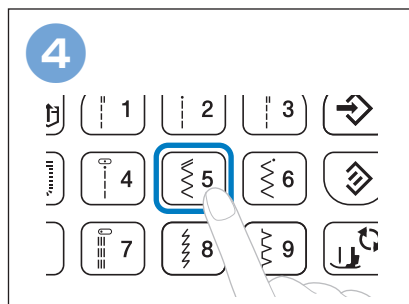
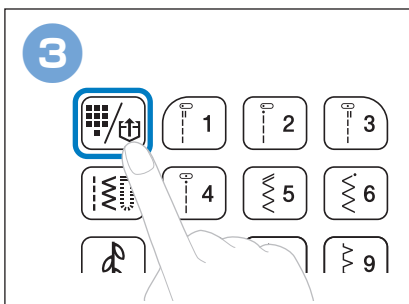
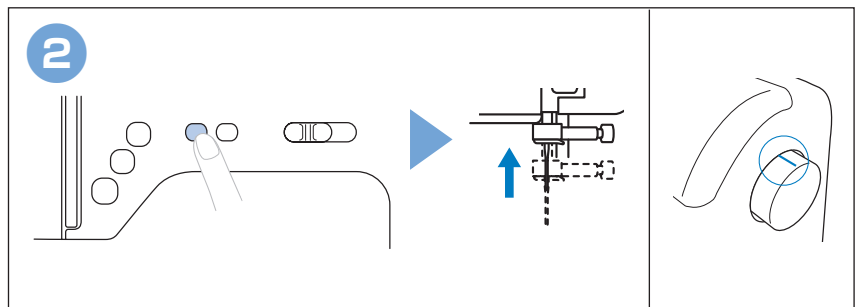
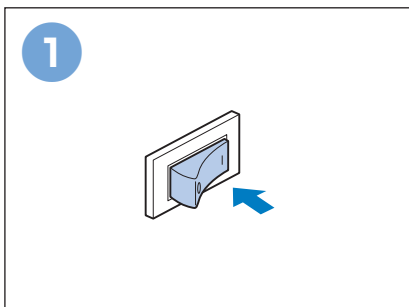

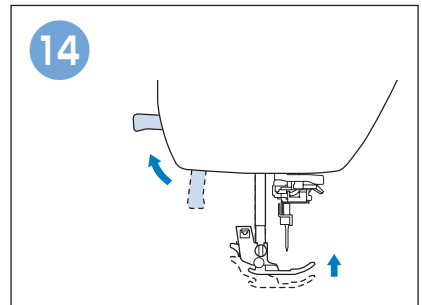
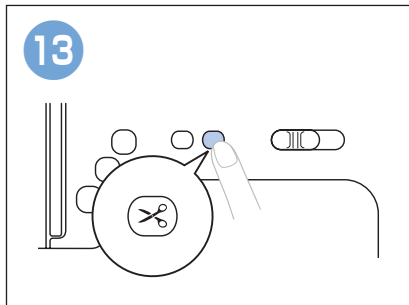
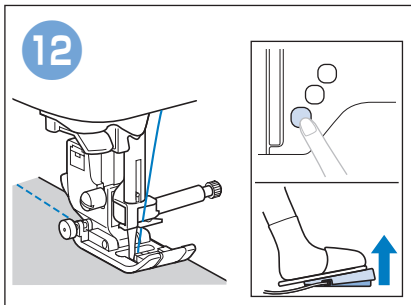
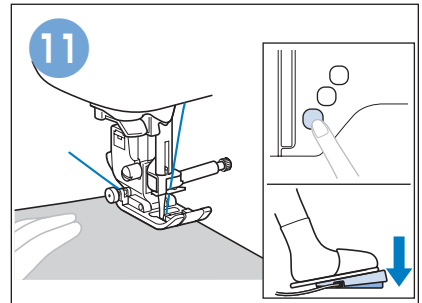
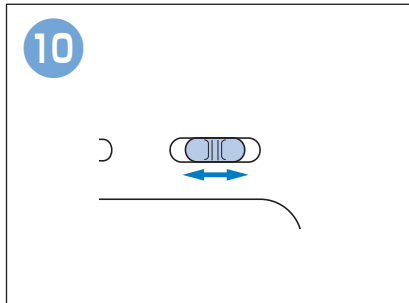
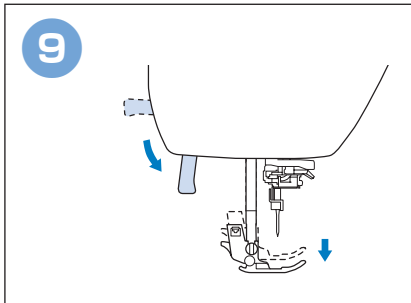
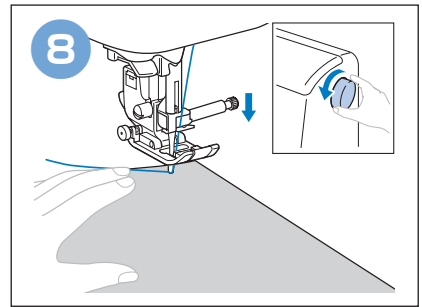
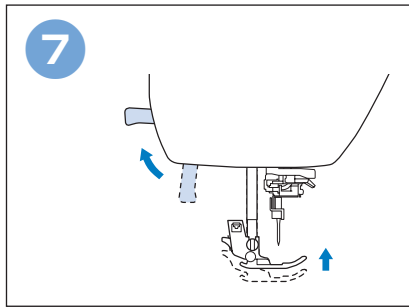
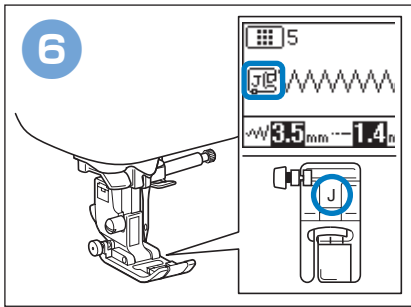

◆ Utility Stitches
◆ Punti utili

◆ Nutzstiche
◆ Puntadas de utilidad

◆ Points de couture courants
◆ Pontos utilitários

◆ Naaisteken
◆ Основные строчки

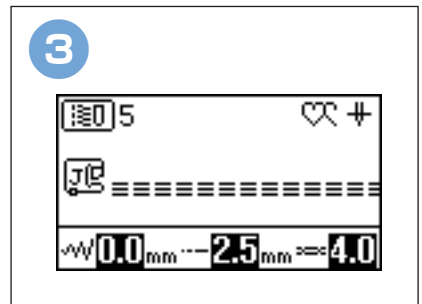
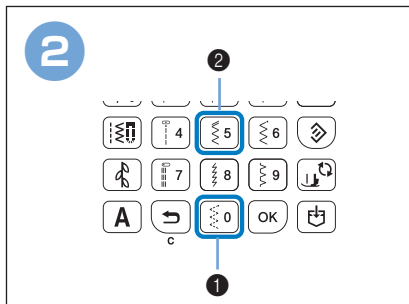
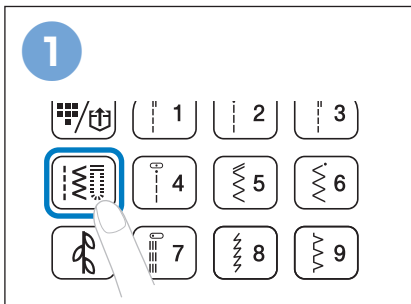

◆ Decorative Stitches ◆ Dekorstiche ◆ Points décoratifs ◆ Decoratieve steken
 ◆ Puntti decorativi ◆ Puntadas decorativas ◆ Pontos decorativos ◆ Декоративные строчки

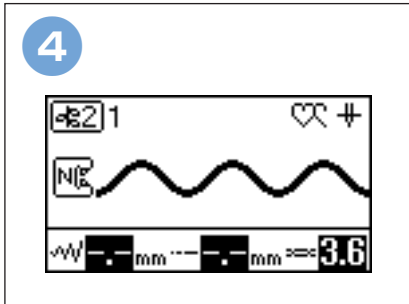
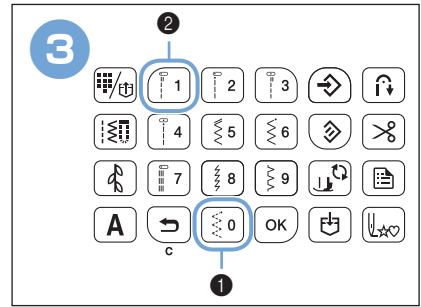
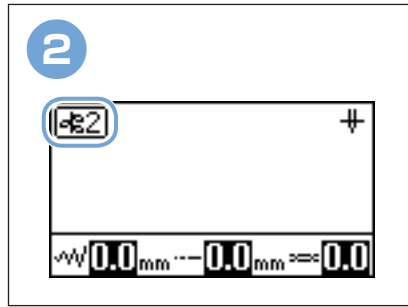
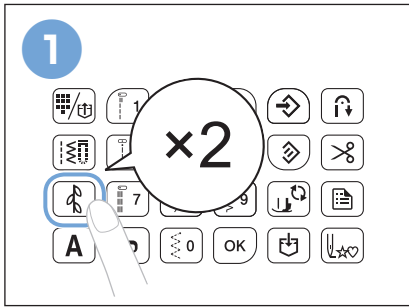

◆ Character stitches ◆ Buchstabenstiche ◆ Points de caractères ◆ Lettersteken
 ◆ Puntti a caratteri ◆ Puntadas de carácter ◆ Pontos de caracteres ◆ Символьные строчки

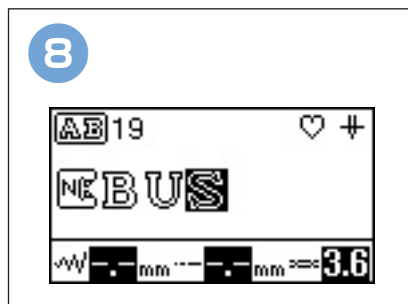
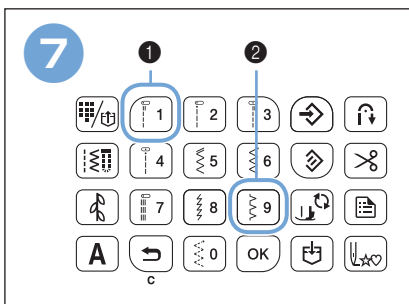
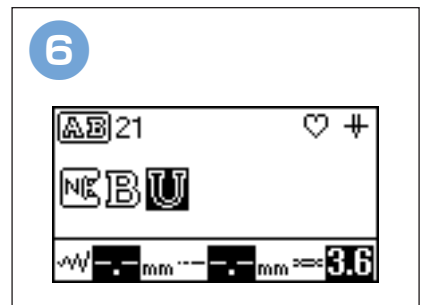
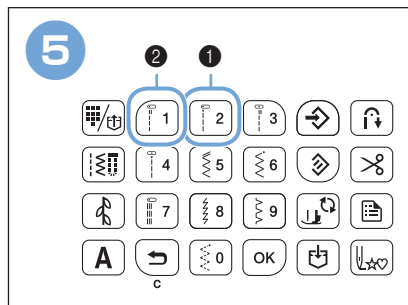
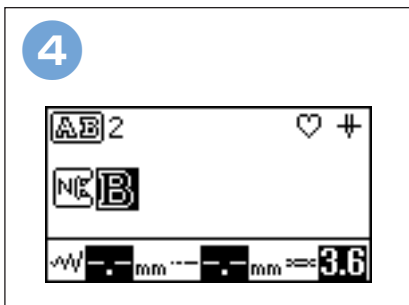
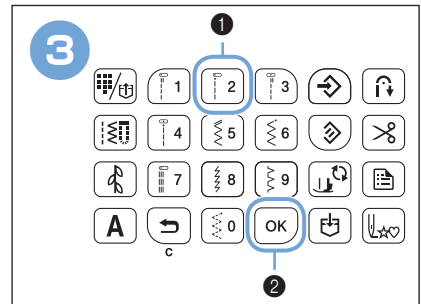
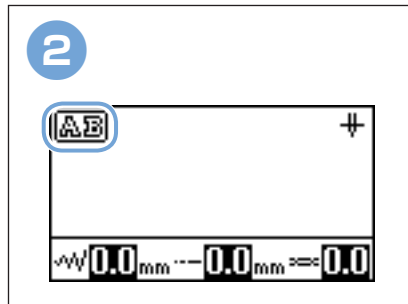
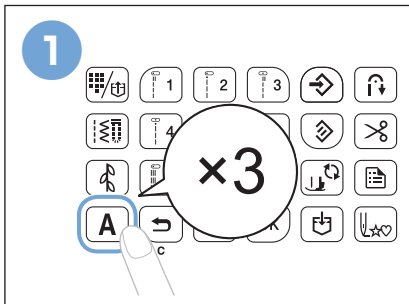



Summary of Stitch Patterns

Stich-Übersicht

Sommaire des motifs de point

Steken overzicht

Sommario degli schemi punto

Resumen de tipos de puntada

Resumo dos padrões de ponto

Рисунки строчек

- ◆ Preset Utility Stitches**
- ◆ Voreingestellte Nutztstiche**
- ◆ Préréglage des points de couture courants**
- ◆ Vooraf ingestelde naaisteken**
- ◆ Punti utili preimpostati**
- ◆ Puntadas de utilidad predefinidas**
- ◆ Pontos utilitários predefinidos**
- ◆ Предварительно заданные основные строчки**



- ◆ Utility Stitches**
- ◆ Nutztstiche**
- ◆ Points de couture courants**
- ◆ Naaisteken**
- ◆ Punti utili**
- ◆ Puntadas de utilidad**
- ◆ Pontos utilitários**
- ◆ Основные строчки**

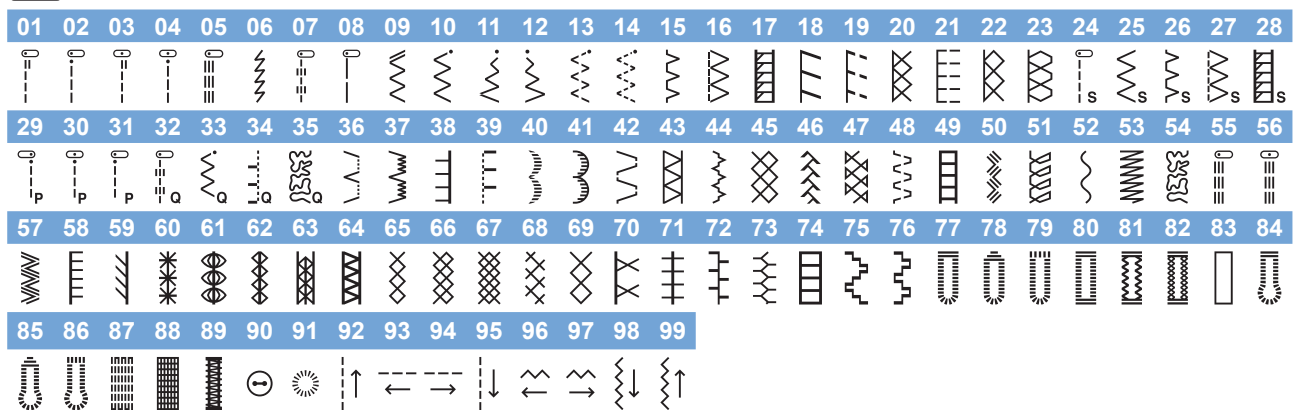

- ◆ Decorative Stitches**
- ◆ Dekorstiche**
- ◆ Points décoratifs**
- ◆ Decoratieve steken**
- ◆ Punti decorativi**
- ◆ Puntadas decorativas**
- ◆ Pontos decorativos**
- ◆ Декоративные строчки**



* 36:Pattern for making adjustment, 97:MY CUSTOM STITCH, 98, 99:Pattern for step stitch
 * 36:Einstellungsmuster, 97:MY CUSTOM STITCH (Mein Stichdesign), 98, 99:Muster für versetzte Stichmuster
 * 36:Motif d'ajustement, 97 : MY CUSTOM STITCH (MON POINT PERSONNALISÉ), 98, 99 : Motifs de points en dégradé
 * 36:patroon voor aanpassing, 97: MY CUSTOM STITCH, 98, 99: patroon voor stapsteek
 * 36:Punto decorativo per eseguire la regolazione, 97:MY CUSTOM STITCH (PUNTI PERSONALIZZATI), 98, 99:Punto decorativo digradante
 * 36: Patrón para hacer el ajuste, 97: MY CUSTOM STITCH (Mi puntada preferida), 98, 99: Patrón para la puntada escalonada
 * 36:Padrão para fazer ajustes, 97:MEU PONTO PERSONALIZADO, 98, 99:Padrão para ponto passo
 * 36:Строчка для выполнения настройки, 97:MY CUSTOM STITCH (Моя строчка), 98, 99:Создание ступенчатой строчки



- Satin stitches (01-12)
7 mm satin stitches (13-29)
Cross stitch stitches (30-43)
- Puntii pleni (01-12)
Puntii pleni da 7 mm (13-29)
Puntii croce (30-43)

- Satinstiche (01-12)
7 mm Satinstiche (13-29)
Kreuzstiche (30-43)
- Costuras para satén (01-12)
Puntadas satinadas de 7 mm (13-29)
Puntadas de punto de cruz (30-43)

- Points plumetis (01-12)
Points plumetis 7 mm (13-29)
Points de croix (30-43)
- Pontos cheios (01-12)
Pontos cheios de 7 mm (13-29)
Pontos em ponto cruz (30-43)

- Satijnsteken (01-12)
7 mm satijnsteken (13-29)
Kruissteken (30-43)
- Атласные строчки (01-12)
Атласные строчки 7 мм (13-29)
Крестовидные строчки (30-43)

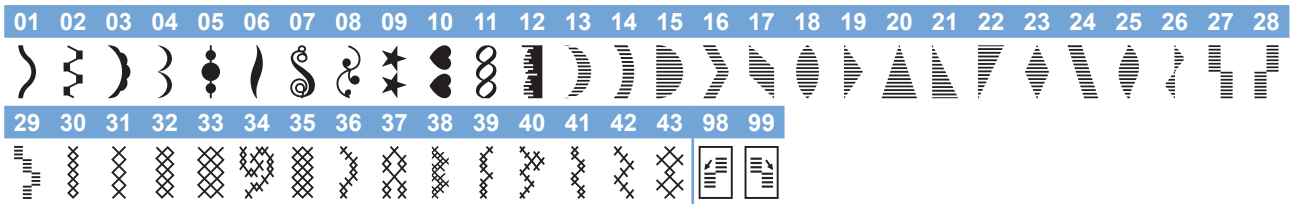

- * 98, 99: Pattern for step stitch
- * 98, 99: patroon voor stapsteek
- * 98, 99: Padrão para ponto passo

- * 98, 99: Muster für versetzte Stichmuster
- * 98, 99: Disegno per punto con avanzamento
- * 98, 99: Создание ступенчатой строчки

- * 98, 99 : Motifs de points en dégradé
- * 98, 99: Patrón para la puntada escalonada



- Utility decorative stitch patterns
- Decoratieve naaisteken
- Padrões de ponto utilitário decorativo

- Dekorative Gebrauchsstichmuster
- Disegni/puntii utili decorativi
- Рисунки основных декоративных строчек

- Motifs de points décoratifs courants
- Puntadas decorativas utilitarias

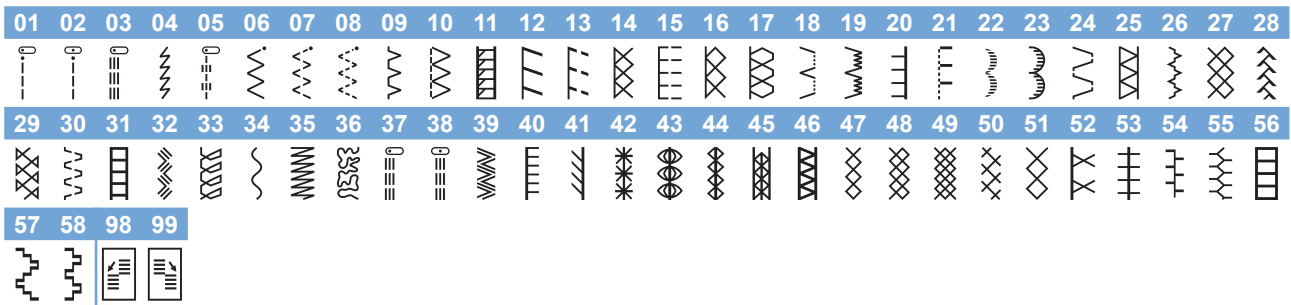

- * 98, 99: Pattern for step stitch
- * 98, 99: patroon voor stapsteek
- * 98, 99: Padrão para ponto passo

- * 98, 99: Muster für versetzte Stichmuster
- * 98, 99: Disegno per punto con avanzamento
- * 98, 99: Создание ступенчатой строчки

- * 98, 99 : Motifs de points en dégradé
- * 98, 99: Patrón para la puntada escalonada

◆ Character stitches
◆ Puntti a caratteri

◆ Buchstabenstiche
◆ Puntadas de carácter

◆ Points de caractères
◆ Pontos de caracteres

◆ Lettersteken
◆ Символьные строчки

A x1 ► AB

- Gothic font
- Carattere Gothic

- Schriftart Gotisch
- Fuente gótica

- Police gothique
- Fonte gótica

- Gothic lettertype
- Готический шрифт

| | | | | | | | | | | | | | | | | | | | | | | | | | | |
|-----|-----|-----|-----|-----|-----|-----|-----|-----|-----|-----|-----|-----|-----|-----|-----|-----|-----|-----|-----|-----|-----|-----|-----|-----|-----|---|
| 1 | 2 | 3 | 4 | 5 | 6 | 7 | 8 | 9 | 10 | 11 | 12 | 13 | 14 | 15 | 16 | 17 | 18 | 19 | 20 | 21 | 22 | 23 | 24 | 25 | 26 | |
| A | B | C | D | E | F | G | H | I | J | K | L | M | N | O | P | Q | R | S | T | U | V | W | X | Y | Z | |
| 27 | 28 | 29 | 30 | 31 | 32 | 33 | 34 | 35 | 36 | 37 | 38 | 39 | 40 | 41 | 42 | 43 | 44 | 45 | 46 | 47 | 48 | 49 | 50 | 51 | 52 | |
| a | b | c | d | e | f | g | h | i | j | k | l | m | n | o | p | q | r | s | t | u | v | w | x | y | z | |
| 53 | 54 | 55 | 56 | 57 | 58 | 59 | 60 | 61 | 62 | 63 | 64 | 65 | 66 | 67 | 68 | 69 | 70 | 71 | 72 | 73 | 74 | 75 | 76 | 77 | 78 | |
| 0 | 1 | 2 | 3 | 4 | 5 | 6 | 7 | 8 | 9 | # | % | \$ | £ | € | ¥ | - | + | x | ÷ | = | * | . | , | & | ? | |
| 79 | 80 | 81 | 82 | 83 | 84 | 85 | 86 | 87 | 88 | 89 | 90 | 91 | 92 | 93 | 94 | 95 | 96 | 97 | 98 | 99 | 100 | 101 | 102 | 103 | 104 | |
| ! | @ | < | > | (|) | [|] | / | \ | ~ | : | ; | © | ® | ™ | “ | ” | ” | ’ | ‘ | ’ | - | À | Ä | Å | |
| 105 | 106 | 107 | 108 | 109 | 110 | 111 | 112 | 113 | 114 | 115 | 116 | 117 | 118 | 119 | 120 | 121 | 122 | 123 | 124 | 125 | 126 | 127 | 128 | 129 | 130 | |
| Æ | à | á | â | ã | ä | å | æ | Ç | ç | Ð | È | É | Ê | Ë | è | é | ê | ë | Ï | Ï | Ì | ì | Í | í | Î | î |
| 131 | 132 | 133 | 134 | 135 | 136 | 137 | 138 | 139 | 140 | 141 | 142 | 143 | 144 | 145 | 146 | 147 | 148 | 149 | 150 | 151 | 152 | 153 | 154 | 155 | 156 | |
| Ñ | ñ | ô | ö | ø | œ | ø | ó | ô | ö | ø | ø | æ | ř | t | Ů | Ů | ù | ú | û | ü | ž | Ɔ | Ɔ | | | |
| 157 | | | | | | | | | | | | | | | | | | | | | | | | | | |
| B | | | | | | | | | | | | | | | | | | | | | | | | | | |

A x2 ► AB

- Handwriting font
- Carattere corsivo

- Schriftart Handschrift
- Fuente de escritura a mano

- Police manuscrite
- Fonte manuscrita

- Handschriftlettertype
- Рукописный шрифт

| | | | | | | | | | | | | | | | | | | | | | | | | | | |
|-----|-----|-----|-----|-----|-----|-----|-----|-----|-----|-----|-----|-----|-----|-----|-----|-----|-----|-----|-----|-----|-----|-----|-----|-----|-----|---|
| 1 | 2 | 3 | 4 | 5 | 6 | 7 | 8 | 9 | 10 | 11 | 12 | 13 | 14 | 15 | 16 | 17 | 18 | 19 | 20 | 21 | 22 | 23 | 24 | 25 | 26 | |
| A | B | C | D | E | F | G | H | I | J | K | L | M | N | O | P | Q | R | S | T | U | V | W | X | Y | Z | |
| 27 | 28 | 29 | 30 | 31 | 32 | 33 | 34 | 35 | 36 | 37 | 38 | 39 | 40 | 41 | 42 | 43 | 44 | 45 | 46 | 47 | 48 | 49 | 50 | 51 | 52 | |
| a | b | c | d | e | f | g | h | i | j | k | l | m | n | o | p | q | r | s | t | u | v | w | x | y | z | |
| 53 | 54 | 55 | 56 | 57 | 58 | 59 | 60 | 61 | 62 | 63 | 64 | 65 | 66 | 67 | 68 | 69 | 70 | 71 | 72 | 73 | 74 | 75 | 76 | 77 | 78 | |
| 0 | 1 | 2 | 3 | 4 | 5 | 6 | 7 | 8 | 9 | # | % | \$ | £ | € | ¥ | - | + | x | ÷ | = | * | . | , | & | ? | |
| 79 | 80 | 81 | 82 | 83 | 84 | 85 | 86 | 87 | 88 | 89 | 90 | 91 | 92 | 93 | 94 | 95 | 96 | 97 | 98 | 99 | 100 | 101 | 102 | 103 | 104 | |
| ! | @ | < | > | (|) | [|] | / | \ | ~ | : | ; | © | ® | ™ | “ | ” | ” | ’ | ‘ | ’ | - | À | Ä | Å | |
| 105 | 106 | 107 | 108 | 109 | 110 | 111 | 112 | 113 | 114 | 115 | 116 | 117 | 118 | 119 | 120 | 121 | 122 | 123 | 124 | 125 | 126 | 127 | 128 | 129 | 130 | |
| Æ | à | á | â | ã | ä | å | æ | Ç | ç | Ð | È | É | Ê | Ë | è | é | ê | ë | Ï | Ï | Ì | ì | Í | í | Î | î |
| 131 | 132 | 133 | 134 | 135 | 136 | 137 | 138 | 139 | 140 | 141 | 142 | 143 | 144 | 145 | 146 | 147 | 148 | 149 | 150 | 151 | 152 | 153 | 154 | 155 | 156 | |
| Ñ | ñ | ô | ö | ø | œ | ø | ó | ô | ö | ø | ø | æ | ř | t | Ů | Ů | ù | ú | û | ü | ž | Ɔ | Ɔ | | | |
| 157 | | | | | | | | | | | | | | | | | | | | | | | | | | |
| B | | | | | | | | | | | | | | | | | | | | | | | | | | |

A x3 ▶ **AB**

- Outline
- Contorno
- Umriss
- Con borde
- Contour
- Contorno
- Contour
- Контурный шрифт

| | | | | | | | | | | | | | | | | | | | | | | | | | |
|-----|-----|-----|-----|-----|-----|-----|-----|-----|-----|-----|-----|-----|-----|-----|-----|-----|-----|-----|-----|-----|-----|-----|-----|-----|-----|
| 1 | 2 | 3 | 4 | 5 | 6 | 7 | 8 | 9 | 10 | 11 | 12 | 13 | 14 | 15 | 16 | 17 | 18 | 19 | 20 | 21 | 22 | 23 | 24 | 25 | 26 |
| A | B | C | D | E | F | G | H | I | J | K | L | M | N | O | P | Q | R | S | T | U | V | W | X | Y | Z |
| 27 | 28 | 29 | 30 | 31 | 32 | 33 | 34 | 35 | 36 | 37 | 38 | 39 | 40 | 41 | 42 | 43 | 44 | 45 | 46 | 47 | 48 | 49 | 50 | 51 | 52 |
| a | b | c | d | e | f | g | h | i | j | k | l | m | n | o | p | q | r | s | t | u | v | w | x | y | z |
| 53 | 54 | 55 | 56 | 57 | 58 | 59 | 60 | 61 | 62 | 63 | 64 | 65 | 66 | 67 | 68 | 69 | 70 | 71 | 72 | 73 | 74 | 75 | 76 | 77 | 78 |
| 0 | 1 | 2 | 3 | 4 | 5 | 6 | 7 | 8 | 9 | # | % | \$ | € | ¥ | - | + | x | ÷ | ≡ | ✖ | . | , | & | ? | |
| 79 | 80 | 81 | 82 | 83 | 84 | 85 | 86 | 87 | 88 | 89 | 90 | 91 | 92 | 93 | 94 | 95 | 96 | 97 | 98 | 99 | 100 | 101 | 102 | 103 | 104 |
| ! | @ | < | > | (|) | [|] | / | \ | ~ | : | : | © | ® | ™ | “ | ” | ” | ’ | ’ | ’ | ’ | ’ | ’ | ’ |
| 105 | 106 | 107 | 108 | 109 | 110 | 111 | 112 | 113 | 114 | 115 | 116 | 117 | 118 | 119 | 120 | 121 | 122 | 123 | 124 | 125 | 126 | 127 | 128 | 129 | 130 |
| Æ | à | á | â | ã | ä | å | æ | Ç | Ç | Ð | É | É | Ê | Ê | È | é | é | ë | í | ÿ | î | î | ï | ï | ï |
| 131 | 132 | 133 | 134 | 135 | 136 | 137 | 138 | 139 | 140 | 141 | 142 | 143 | 144 | 145 | 146 | 147 | 148 | 149 | 150 | 151 | 152 | 153 | 154 | 155 | 156 |
| Ñ | Ñ | ñ | ô | ö | ø | œ | ò | ó | ô | õ | ø | œ | ř | t | û | û | ù | ú | ú | ù | ù | ù | ù | ù | ù |
| 157 | | | | | | | | | | | | | | | | | | | | | | | | | |
| ß | | | | | | | | | | | | | | | | | | | | | | | | | |

A x4 ▶ **AB**

- Cyrillic font
- Carattere cirillico
- Schriftart Kyrillisch
- Fuente cirilica
- Police cyrillique
- Fonte cirilica
- Cyrillisch lettertype
- Русский шрифт

| | | | | | | | | | | | | | | | | | | | | | | | | | |
|-----|-----|-----|-----|-----|-----|-----|-----|-----|-----|-----|----|----|----|----|----|----|----|----|----|----|-----|-----|-----|-----|-----|
| 1 | 2 | 3 | 4 | 5 | 6 | 7 | 8 | 9 | 10 | 11 | 12 | 13 | 14 | 15 | 16 | 17 | 18 | 19 | 20 | 21 | 22 | 23 | 24 | 25 | 26 |
| А | Б | В | Г | Д | Е | Ё | Ж | З | И | Й | К | Л | М | Н | О | П | Р | С | Т | У | Ф | Х | Ц | Ч | Ш |
| 27 | 28 | 29 | 30 | 31 | 32 | 33 | 34 | 35 | 36 | 37 | 38 | 39 | 40 | 41 | 42 | 43 | 44 | 45 | 46 | 47 | 48 | 49 | 50 | 51 | 52 |
| Щ | Ъ | Ы | Ь | Э | Ю | Я | Г | Є | І | Ї | Ў | Ҁ | ҁ | Ј | Љ | Њ | Ќ | Ѓ | Ѕ | Њ | а | б | в | г | д |
| 53 | 54 | 55 | 56 | 57 | 58 | 59 | 60 | 61 | 62 | 63 | 64 | 65 | 66 | 67 | 68 | 69 | 70 | 71 | 72 | 73 | 74 | 75 | 76 | 77 | 78 |
| е | ё | ж | з | и | й | к | л | м | н | о | п | р | с | т | у | ф | х | ц | ч | ш | щ | ъ | ы | ь | э |
| 79 | 80 | 81 | 82 | 83 | 84 | 85 | 86 | 87 | 88 | 89 | 90 | 91 | 92 | 93 | 94 | 95 | 96 | 97 | 98 | 99 | 100 | 101 | 102 | 103 | 104 |
| ю | я | г | є | і | ї | ў | Ҁ | ҁ | ј | љ | њ | ќ | ѓ | ѕ | ќ | 0 | 1 | 2 | 3 | 4 | 5 | 6 | 7 | 8 | 9 |
| 105 | 106 | 107 | 108 | 109 | 110 | 111 | 112 | 113 | 114 | 115 | | | | | | | | | | | | | | | |
| — | . | , | & | ? | ! | (|) | / | ' | _ | | | | | | | | | | | | | | | |

A ×5 ▶ **あい**

- Japanese font
- Carattere giapponese
- Schriftart Japanisch
- Fuente japonesa
- Police japonaise
- Fonte japonesa
- Japans lettertype
- Японский шрифт

| | | | | | | | | | | | | | | | | | | | | | | | | | |
|-----------------------------|-----|-----|-----|-----|-----|-----|-----|-----|-----|-----|-----|-----|-----|-----|-----|-----|-----|-----|-----|-----|-----|-----|-----|-----|-----|
| 1 | 2 | 3 | 4 | 5 | 6 | 7 | 8 | 9 | 10 | 11 | 12 | 13 | 14 | 15 | 16 | 17 | 18 | 19 | 20 | 21 | 22 | 23 | 24 | 25 | 26 |
| あいうえおあいうえおかきくけこがぎぐげごさしすせそざ | | | | | | | | | | | | | | | | | | | | | | | | | |
| 27 | 28 | 29 | 30 | 31 | 32 | 33 | 34 | 35 | 36 | 37 | 38 | 39 | 40 | 41 | 42 | 43 | 44 | 45 | 46 | 47 | 48 | 49 | 50 | 51 | 52 |
| じずぜぞたちつてとだぢづでどっなにぬねのはひふへほば | | | | | | | | | | | | | | | | | | | | | | | | | |
| 53 | 54 | 55 | 56 | 57 | 58 | 59 | 60 | 61 | 62 | 63 | 64 | 65 | 66 | 67 | 68 | 69 | 70 | 71 | 72 | 73 | 74 | 75 | 76 | 77 | 78 |
| びぶべぼびびべまみむめもやゆよゃゅよらりるれろわ | | | | | | | | | | | | | | | | | | | | | | | | | |
| 79 | 80 | 81 | 82 | 83 | 84 | 85 | 86 | 87 | 88 | 89 | 90 | 91 | 92 | 93 | 94 | 95 | 96 | 97 | 98 | 99 | 100 | 101 | 102 | 103 | 104 |
| をんアイウエオァィウェォヴカキクケコガギグゲゴサシス | | | | | | | | | | | | | | | | | | | | | | | | | |
| 105 | 106 | 107 | 108 | 109 | 110 | 111 | 112 | 113 | 114 | 115 | 116 | 117 | 118 | 119 | 120 | 121 | 122 | 123 | 124 | 125 | 126 | 127 | 128 | 129 | 130 |
| セソザジズセゾタチツテトダヂヅデドッナニヌネノハヒフ | | | | | | | | | | | | | | | | | | | | | | | | | |
| 131 | 132 | 133 | 134 | 135 | 136 | 137 | 138 | 139 | 140 | 141 | 142 | 143 | 144 | 145 | 146 | 147 | 148 | 149 | 150 | 151 | 152 | 153 | 154 | 155 | 156 |
| へホバビブベボパピプペポマミムメモヤユヨャュョラリル | | | | | | | | | | | | | | | | | | | | | | | | | |
| 157 | 158 | 159 | 160 | 161 | 162 | 163 | 164 | 165 | 166 | 167 | 168 | 169 | 170 | 171 | 172 | 173 | 174 | 175 | 176 | 177 | 178 | 179 | 180 | 181 | 182 |
| レロフヲン01234567890ー二三四五六七八九十 | | | | | | | | | | | | | | | | | | | | | | | | | |
| 183 | 184 | 185 | 186 | 187 | 188 | 189 | 190 | 191 | 192 | 193 | 194 | 195 | 196 | 197 | 198 | 199 | 200 | 201 | 202 | 203 | 204 | 205 | 206 | 207 | 208 |
| &?!()ー生年月日才保育幼稚園小中学校組部火水木金 | | | | | | | | | | | | | | | | | | | | | | | | | |
| 209 | 210 | | | | | | | | | | | | | | | | | | | | | | | | |
| 土 _ | | | | | | | | | | | | | | | | | | | | | | | | | |

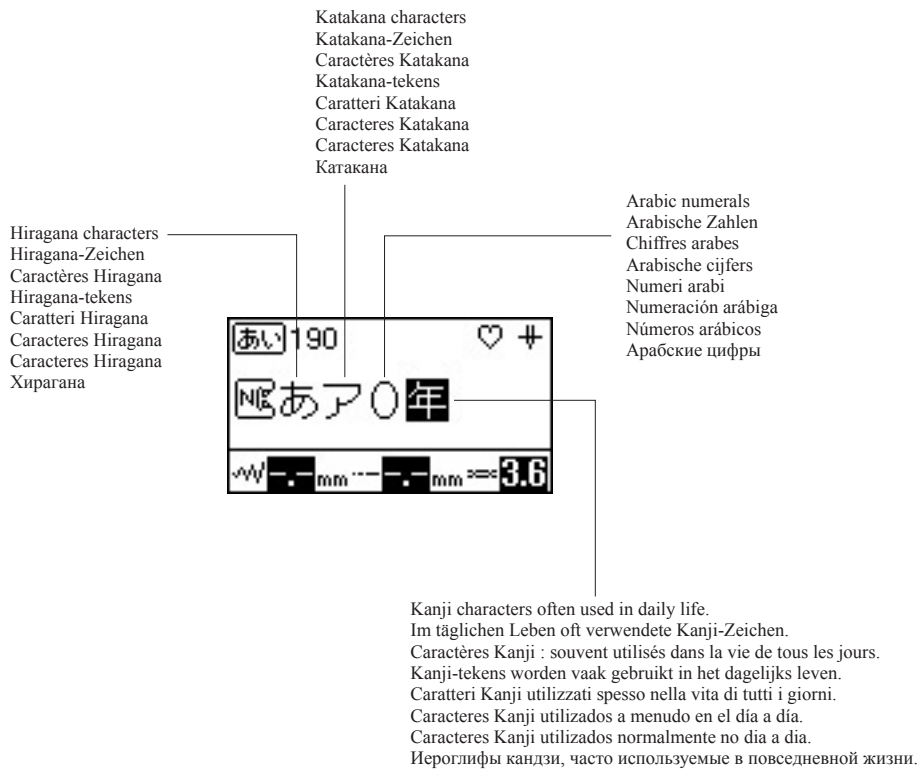

- Example of Kanji characters in daily life
- Beispiel für alltägliche Kanji-Zeichen
- Exemple de caractères Kanji dans la vie quotidienne
- Voorbeeld van Kanji-tekens in het dagelijks leven
- Esempio di caratteri kanji nella vita di ogni giorno
- Ejemplo de caracteres Kanji en la vida cotidiana
- Exemplo de caracteres Kanji no dia a dia
- Примеры использования иероглифов кандзи в повседневной жизни

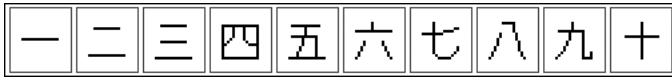

1, 2, 3, 4, 5, 6, 7, 8, 9, 10



Date of birth
Data di nascita

Geburtsdatum
Fecha de nacimiento

Date de naissance
Data de nascimento

Geboortedatum
Дата рождения

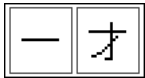

1 year old
1 anno di età

1 Jahr alt
1 año de edad

1 an
1 ano

1 jaar oud
Возраст 1 год



Nursery school
Asilo nido

Vorschule
Guardería

Crèche
Escola maternal

Peuterspeelzaal
Ясли



Kindergarten
Scuola materna

Kindergarten
Jardín de infancia

École maternelle
Jardim de infância

Kleuterschool
Детский сад



Elementary school
Scuola elementare

Grundschule
Escuela primaria

École primaire
Ensino básico

Basisschool
Начальная школа



Junior high school
Scuola superiore

Realschule
Escuela secundaria

Collège
Ensino médio

Middelbare school
Средняя школа



Group/Class
Gruppo/classe

Gruppe/Klasse
Grupo/Clase

Groupe/Classe
Grupo/Classe

Groep/klas
Группа, класс



Club/Division
Club/sezione

Club/Abteilung
Club/División

Club/Division
Clube/Divisão

Club/Divisie
Клуб, подразделение



Moon/Monday
Luna/lunedì

Mond/Montag
Luna/Lunes

Lune/Lundi
Lua/Segunda-feira

Maan/Maandag
Луна, понедельник



Fire/Tuesday
Fuoco/martedì

Feuer/Dienstag
Fuego/Martes

Feu/Mardi
Fogo/Terça-feira

Vuur/Dinsdag
Огонь, вторник



Water/Wednesday
Acqua/mercoledì

Wasser/Mittwoch
Agua/Miércoles

Eau/Mercredi
Água/Quarta-feira

Water/Woensdag
Вода, среда



Tree/Thursday
Albero/giovedì

Baum/Donnerstag
Árbol/Jueves

Arbre/Jeudi
Árvore/Quinta-feira

Boom/Donderdag
Дерево, четверг



Gold/Friday
Oro/venerdì

Gold/Freitag
Oro/Viernes

Or/Vendredi
Ouro/Sexta-feira

Goud/Vrijdag
Золото, пятница



Soil/Saturday
Terra/sabato

Erde/Samstag
Tierra/Sábado

Terre/Samedi
Terra/Sábado

Grond/Zaterdag
Земля, суббота



Sun/Sunday
Sole/domenica

Sonne/Sonntag
Sol/Domingo

Soleil/Dimanche
Sol/Domingo

Zon/Zondag
Солнце, воскресенье



January 1st (Monday)
1° gennaio (lunedì)

1. Januar (Montag)
1 de enero (lunes)

1er janvier (lundi)
1° de janeiro (Segunda-feira)

1 januari (maandag)
1 января (понедельник)

English
German
French
Dutch
Italian
Spanish
Portuguese-BR
Russian
888-H82
Printed in Vietnam



XG5476-101①